

# *Stratos-HSSD* **2**

**High Sensitivity Smoke Detector**



Installer's Handbook • LM80004 • Issue 12

## Contents

	page
Introduction	3
1. Types of detector	4
2. Controls and indicators	8
3. Programming the unit	10
4. Sampling pipe design	25
5. Installation	26
6. External communications	36
7. Event log	38
8. Interfacing	39
9. Commissioning	44
10. Maintenance	45
11. Troubleshooting	47
12. Error messages	49
13. Do's and Don'ts	50
14. Stratos-HSSD-2 specification	51

Reproduction of this document is strictly prohibited unless express written permission is obtained from Kidde Products Ltd.

In line with continuous product improvement Kidde Products Ltd. reserves the right to modify or update specifications without notice.

Stratos-HSSD, Stratos-Quadra, SenseNET, Stratos-Micra, FastLearn and ClassiFire are trademarks of Kidde Products Ltd.

Copyright © 2011 Kidde Products Ltd.

## Introduction



0832

Kidde Products Limited  
Unit 2 Blair Way Dawdon  
City: Seaham, County Durham  
SR7 7PP, UK

09  
0832-CPD-1076  
0832-CPD-1077  
0832-CPD-1078

EN54-20: 2006

Aspirating smoke detectors  
for fire detection and fire alarm  
systems for buildings

Class A, B and C

Technical data: see INF48022 and  
INF48023 held by the manufacturer

Stratos-HSSD-2<sup>®</sup> is a highly sophisticated 'next generation' of High Sensitivity Aspirating Smoke Detection product that has been designed to ensure that installation and commissioning is as simple as possible, while optimising performance.

Stratos incorporates a patented 'artificial intelligence' known as ClassiFire<sup>®</sup>, which allows the detector to configure itself to optimum sensitivity, alarm thresholds and minimum nuisance alarms for any environment.

ClassiFire intelligence also monitors the detector chamber and dust separator for contamination, continually adjusting the appropriate operating parameters to counteract the negative effects of such contamination.

Stratos is unique in being able to provide a consistent level of protection in a very wide range of environments by continuously making minor adjustments to sensitivity.

Stratos has proven its worth many times by detecting 'difficult-to-detect' slow growth electrical overload incipient fires in 'difficult' environments.

This handbook gives information likely to be needed for most installations, but for more detailed information on subjects such as Fresh Air Referencing, please refer to the complete Technical Manual or System Design Guide.

This equipment is Class 111 as defined in EN60950 (i.e., this equipment is designed to operate from Safety Extra Low Voltages and does not generate any hazardous voltages).

As this equipment is part of a fire detection system, it should be supplied from an approved power supply conforming to EN54-4.



This symbol appears on the main board of the unit and indicates that the board contains static sensitive components. Suitable anti-static precautions must be taken when handling the board, eg. for fuse replacement.



This label is located on the laser chamber at the bottom right of the open detector and signifies that the unit is a Class 1 Laser product as specified in IEC 60825-1. The unit incorporates a Class 3B embedded laser which must not be removed from the detector as retinal damage may result if the laser beam enters the eye.



This symbol indicates the Safety Earth studs (see sections 1.3 and 1.4). These are for grounding cable screens etc. and should not be connected to 0V or signal earth.



**HELP LINE**  
(+44) (0) 1844 265004

Kidde Products Ltd. has taken every care to ensure that Stratos is as simple to install as possible but in case of difficulty, please contact our Help Line to ensure trouble free installation and operation.

Kidde Products Ltd. takes no responsibility for damage or injury occasioned as a result of failing to install or operate the equipment in accordance with these instructions.

Throughout this manual, where an entry is shown as **Example**, this is intended as a representation of the text appearing on the LCD screen on the detector (if fitted) when the option is selected, eg **Setup menu**.

Entries shown as **<EXAMPLE>** represent function buttons on the front of the detector, eg. **<TEST>**.

## 1. Types of Detector



### 1.1 Standard Detector

The Standard Detector may be operated as a stand-alone unit, or may be part of a network of detectors centrally monitored by a Command Module (see section 1.2). It may be programmed via the front panel as in the version shown above. Alternatively, and for detectors ordered without front panel display, the detector may be programmed remotely via the detector's RS485 terminals using a Command Module, or via the detector's RS232 port using a PC running Remote Control software. A copy of this software is packed with each detector supplied.



### 1.2 Stand alone Command Module/ Command Module detector

When multiple detectors are networked together, a Command Module may be used to tie all the detectors together and to provide a central point for programming, running diagnostics and PC and fire panel connection.

The Command Module can be mounted either inside a detector as shown or as a stand-alone unit in its own housing without an aspirator or smoke detection circuitry. If detectors attached to the Command Module are mounted in different fire zones then the Command Module must be mounted in its own housing with separate power supply to comply with BS5839 and EN54.

When a Command Module is mounted inside a detector, the Standard Detector display is replaced with a dedicated Command Module display. The programming buttons and display on the front of the detector belong to the Command Module.

Programming from the Command Module is very similar to programming a detector, the main difference being that the Command Module has extra functions to control all the Stratos detectors connected to the detector loop.

**1.3 Standard  
Detector interior  
view**

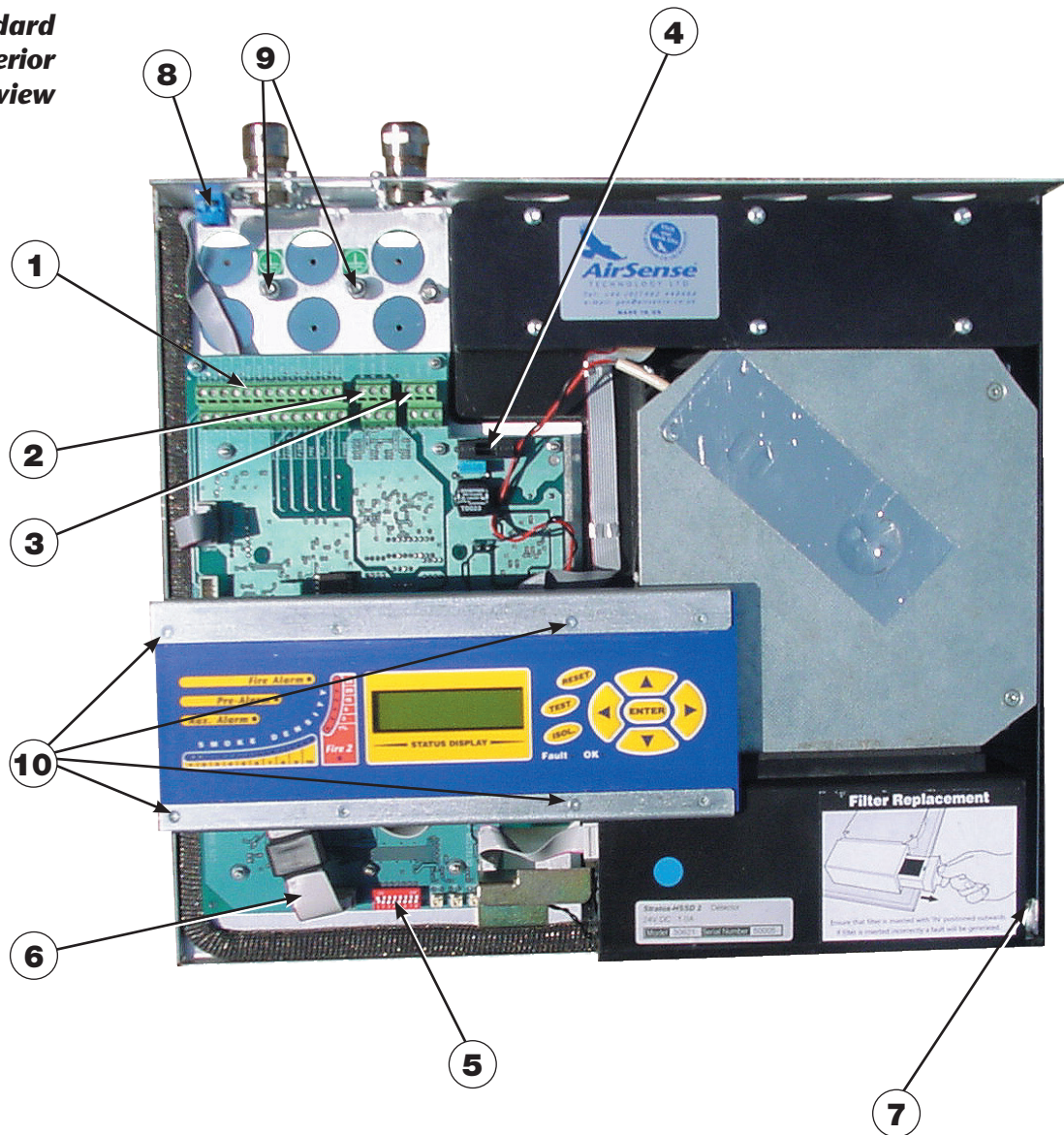

1. Terminal block connections (see section 5.3.1)
2. RS485 terminal connections (see section 5.3.1)
3. 24VDC power supply connections (see section 5.4.1)
4. 1A 5 x 20mm T-type protection fuse
5. Detector address DIP switch (see section 8.1)
6. Front panel display connector
7. Filter removal tab (see section 10)
8. RS232 serial port (see section 8.5)
9. Safety earth studs (see section 5.4)
10. Display fixing screws (see section 5.2.1)



### 1.4 Stand-alone command module interior view

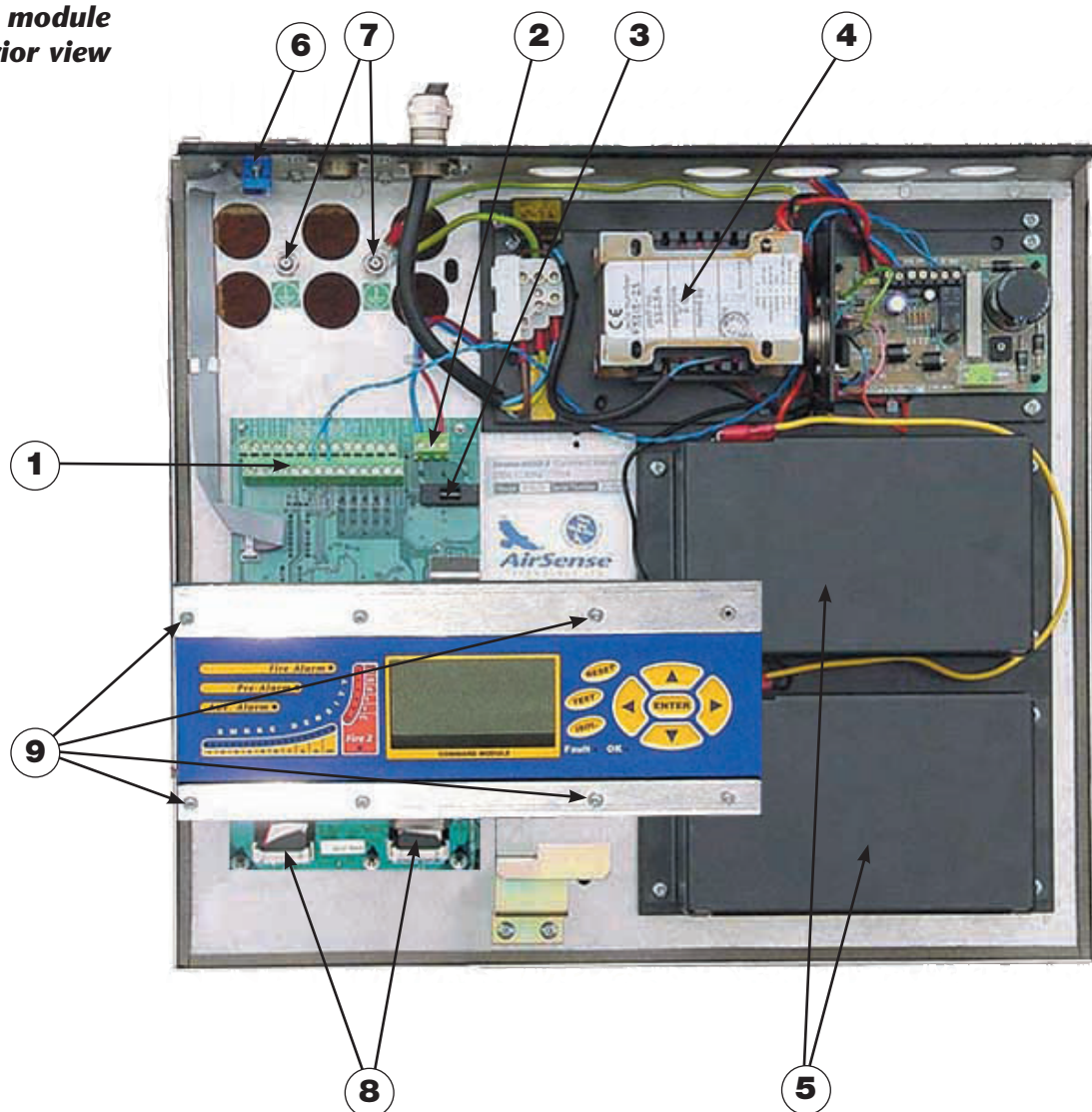

1. Terminal block connections (see section 5.3.2)
2. 24VDC power supply connections (see section 5.4.2)
3. 500mA 5 x 20mm T-type protection fuse
4. Internal power supply (see section 5.4.3)
5. Stand-by batteries (see section 5.4.4)
6. RS232 serial port
7. Safety earth studs (see section 5.4)
8. Front panel display connectors
9. Display fixing screws (see section 5.2.1)

### 1.5 Command module detector interior view

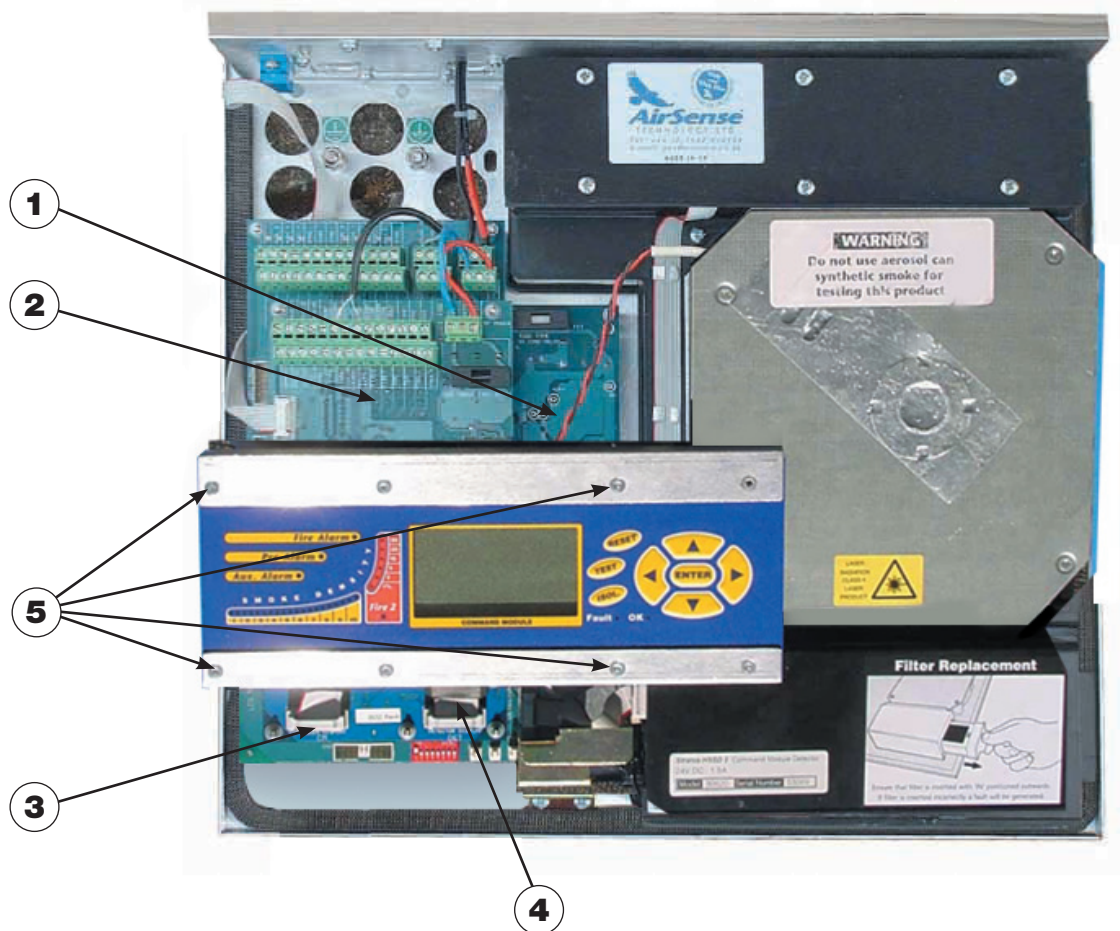

1. Detector CPU board (see section 1.3)
2. Command Module CPU board (see section 1.4)
3. Command Module display connection
4. Detector display connection
5. Display fixing screws (see section 5.2.1)

## 2. Controls and Indicators

Standard Detector

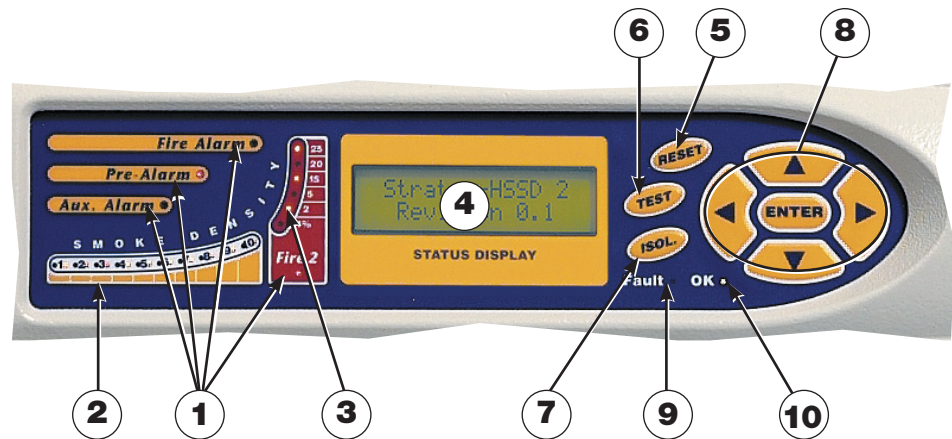

Command Module detector

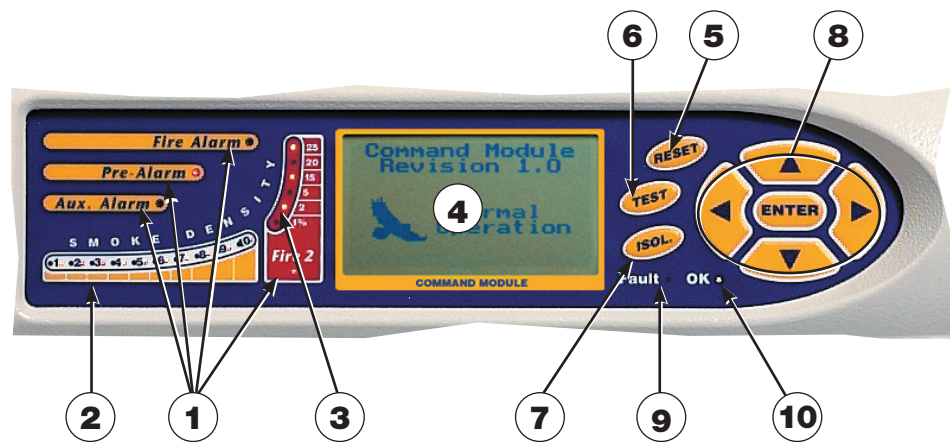

- 1 Aux, Pre-Alarm, Fire 1 and Fire 2 indicators illuminate when the appropriate alarm level has been reached and the appropriate time delays have expired. On a stand-alone Command Module, the indicators signify an alarm condition from any detector on the communications loop.
- 2 3 Smoke density indicators. This display is in two sections. The first part, labelled 1 to 10, is the relatively scaled ClassiFire® bargraph and changes in steps of half a segment. The second part displays absolutely scaled smoke levels above 1% obscuration per metre (% obs/m) to a maximum of 25% obs/m. The Fire 2 activation level is programmed normally somewhere in this range. The bargraph display will show a continually cycling pattern when the unit is in FastLearn mode. On the Command Module display, this will occur when any unit on the RS485 communications loop is in FastLearn. Otherwise, the bargraph display on the Command Module will mimic the bargraph display on the highest-reading detector on the loop.
- 4 Status display (if fitted). This display shows all events as they happen in real time and is also used to configure the unit. See Section 3, 'Programming the unit' for more information.
- 5 RESET. When enabled, pressing <RESET> will clear any latched alarms or faults and set the status display back to its normal operation display. To comply with national standards, detectors are supplied with the RESET function disabled as default.









6 TEST. When enabled, pressing **<TEST>** will start a lamp test and then the detector will show its nominal operating sensitivity as calculated by the ClassiFire Artificial Intelligence System.

7 ISOL. Pressing **<ISOL>** will toggle the unit's isolation state. When isolated, the unit cannot generate any alarms and will signal a fault condition and the text display will show **Panel Isolate**. To comply with national standards, detectors are supplied with the ISOL button disabled as default.

**NB** 

Note: these three buttons can be individually enabled or disabled. The factory default state of the detector is for only the **<TEST>** button to be enabled and for **<RESET>** and **<ISOL>** to be disabled.

8  , , , . These buttons, also referred to in the text as menu buttons or by name, e.g. **<ENTER>**, are used when programming the unit, which is pass code protected. See section 3, 'Programming the unit' for more information.; Pressing  or  when not in programming mode (the access code has NOT been entered) will scroll through the detector's event log. See section 7 'Event log' for more information.

9 Fault. Illuminates when the unit has a fault and a fault signal is being sent to the fire alarm panel. On the Command Module, this also indicates a fault in a detector on the communications loop, or in the loop itself.

10 OK. Illuminates to show normal operation when there are no faults. On the Command Module this means that the Command Module and all detectors on the loop are operating normally.

## 2.1, Types of display

The Standard Detector display is a two-line LCD which allows basic programming of the detector.



```
Latching faults
Enter Yes/No:
Yes
```

The Command Module display contains more information than that for the Standard Detector and prompts the user with the action expected by the use of graphic symbols.

```
Latching faults
Enter Yes/No:
Yes Press
 to change
```



### 3. Programming the unit





The Stratos-HSSD-2 programmer means that programming and configuration of the unit can be performed without opening the detector case.

To enter programming mode, press any of the program menu keys ,  or .

#### 3.1 Engineering Access code





The Engineering Access code is required to allow the detector parameters to be programmed. The access code is only valid whilst the user is in programming mode. It will need to be entered again if programming mode is exited, if the detector is powered down or if **<RESET>** is pressed.

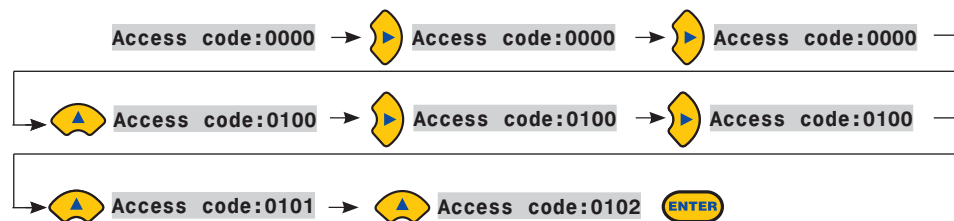

To enter programming mode, press a menu key , , . The unit responds by displaying the prompt **Access code:0000** asking for the engineering access code. The factory default access code is 0102. To enter the default access code, follow the sequence shown.

**NB**  Note: Pressing ,  has no effect until  is pressed to place the cursor under the first digit.





This correctly sets the access code. If an incorrect access code is entered or **<RESET>** is pressed, the display will show **Bad access code**. Pressing a menu key will prompt the user again for the correct access code.

All of the programmable functions work in a similar manner. The ,  keys move the cursor position through the user-settable digits and the ,  keys step through the available values for the currently selected digit (e.g. 1 - 99, Yes / No etc) pressing  enters the displayed figure. Note that it is not possible to save an illegal value, e.g. for the Fire 1 level the maximum valid input is 10 and it would be possible to enter 99, but the programmer will display **Bad value** to inform you that the entry is invalid and prompt for the value to be re-entered. All programmable parameters have the valid input values range in brackets below the parameter legend on the display.

Having edited the value as required, press,  to select the amended setting. Pressing  when the cursor is on the right most digit has the same effect. If no programming activity is detected for 5 minutes, the detector will display the legend **Access timeout** and exit programming mode.

### 3.2 Main menu

When the correct access code is entered, the display will show the main menu. The current selection is always shown with an arrow after it. Press  or  to activate the selection.

The choices available in the main menu are, in order:

**Setup menu** : contains all the user-programmable functions



**Log menu** : Allows the user to view historical information such as the event log (time and date of various events such as alarm or fault conditions)

**Diagnostic menu** : Contains a number of detector self-tests



**Reset** : Clears any latched fault readings or exits from a menu item to its parent menu. This has the same effect as pressing the **<RESET>** button.

**Isolate** : Isolates the detector. This has the same effect as isolating with the **<ISOL>** button,



**Exit** : Exits programming mode

**NB**  The main menu 'wraps around' so that pressing  when in **Setup menu** brings up **Exit** etc.

### 3.3 Navigating through the menus

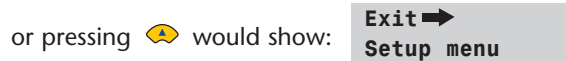
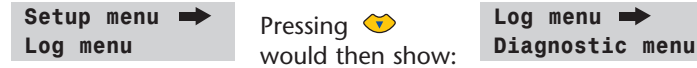

To navigate through the main menu options, press   to navigate through the available choices. The display shows two adjacent items, e.g.





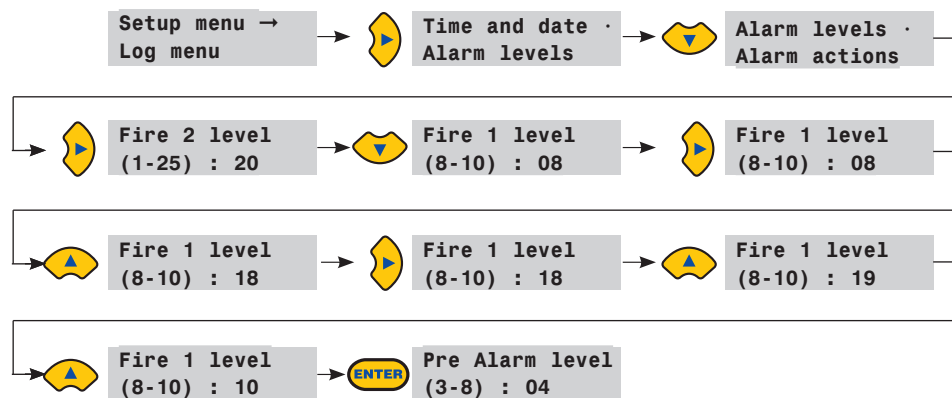





i.e.,  selects items lower in the list by effectively scrolling the screen UP, and vice versa for .

The currently selected item is the upper item of the two and is identified by a trailing arrow as shown (for a menu) or a trailing dot (for a menu item or single choice such as **Exit**). When you have the menu you require, press . This then gives you a choice of the items within the selected menu, e.g. as follows to set the main fire alarm level.



Having entered the **Fire 1 level**, the selected item indicator steps along to the item below it in the **Alarm levels** submenu. Either this can be edited as above, or   can be used to move to the next choice. Once the last entry in the sub-menus reached pressing  will move you back up to the **Setup menu**. Pressing **<RESET>** at any time exits programming mode, assuming the **<RESET>** button is enabled.

Section 3.5 shows the full menu map for the Stratos-HSSD-2, showing the choices available within each menu and submenu.   Move the menu pointer progressively towards the left or right of the map as appropriate, and   step up/down the choices in the currently selected menu or submenu. Items within sub-menus are sequentially accessed with the  button followed by the  button. Values are edited with  followed by  .



### **3.4 Stratos-HSSD-2 functions**

A list of all programmable functions follows with an explanation of their usage and the menu and submenu in which they can be found. The location of each sub-menu and function within the main menu is shown in the menu map (section 3.5). The menu map also shows the valid input range for programming parameters.

Each function listed below gives the following information:

- Function name and description
- Type of function. There are five types of function: Yes/No, Numeric, Alpha, (alphanumeric), Display and Test. In the case of Display and Test functions the user cannot amend the parameters shown.
- The menu and submenu within which the function can be found.
- Applicability. The legend “CM only” means that the function applies only to the Command Module and is not present in the Standard Detector’s list. The legend “Address 000-127” means that the function may apply to the Command Module and the Standard Detector (allowable addresses from 000 to 127). **Time and date** and **Relay test** are examples of these.

All other functions are present in both the Standard Detector and Command Module function lists and are used to program the detectors. They can either be remotely set on the Command Module, or locally on the detector front panel. These are annotated “Address 001-127” since they do not apply to the Command Module itself.

Where a programmable function on the Command Module applies to a Standard Detector, the Command module will scan the loop and, if more than one detector is present, will prompt the user for the address of the detector to be programmed. If the function applies to the Command Module, the address “000” should be entered. For other detectors on the loop (including the detector element of a Command Module detector), the value is the same as the address set on the detector’s internal DIP switch. If a user enters an address which does not appear on the loop, the error message **Bad detector** will appear.

This message will also appear if the Command Module address “000” is entered into a function which only applies to detectors, i.e. anything except “CM only” and “Address 000-127” functions.

#### **3.4.1. Time and date (Numeric - Address 000-127)**

##### **Setup menu > Time and Date**

It is important that the time and date be set up correctly on the controller’s internal calendar/clock because it uses this information to store events in the event log. See section 3.7, “Event log” for more details. Unless specially ordered, units are supplied with the correct setting for UK time. This is backed up with a rechargeable battery. Later adjustments to the clock setting should not exceed  $\pm 70$  minutes unless a FastLearn is initiated

### 3.4.2 Alarm levels (Numeric - Address 001-127)

Setup menu > Alarm levels

The value set in the **Pre Alarm level**, **Fire 1 level** and **Aux level** functions in the **Alarm levels** submenu is the relatively scaled bargraph level at which the appropriate alarm is initiated on the detector. The **Fire 2 level** function assigns an absolutely scaled alarm level in % obs/m to the Fire 2 alarm.

**NB**  The **Aux level** is set by factory default at level 10 which means that this alarm will occur after the Fire 1 alarm.

### 3.4.3 Alarm delays (Numeric - Address 001-127)

Setup menu > Alarm levels

The alarm delay is the number of seconds that an alarm level has to be continuously sensed before the alarm is initiated. Each alarm level has a programmable delay of between 0 and 90 seconds.

### 3.4.4. ClassiFire® override (Numeric - Address 001-127)

Setup menu > Alarm levels

When this function is set to a value other than zero, the shorting together of the "Input 3" contacts on the detector main circuit board by means of volt free contacts will desensitise the detector by moving the alarm levels out by the specified percentage.

### 3.4.5. ClassiFire® alarm factor (Numeric - Address 001-127)

Setup menu > Alarm levels

The detector sensitivity is set with this entry, **which** will also affect the probability of nuisance alarms. 0 = high sensitivity, higher probability, 8 = low sensitivity, lower probability.

**NB**  Note: The highest sensitivity setting is suitable for clean, environmentally controlled environments, e.g. semiconductor manufacturing clean rooms where airborne pollutants are kept to an absolute minimum and the least contamination is cause for alarm. Use of this setting in a busy machine shop would lead to relatively frequent nuisance alarms due to the normal variation of atmospheric contamination and a lower sensitivity setting is recommended. It is therefore important that the alarm factor chosen is suitable for the area to be protected. When the appropriate alarm factor for the protected area has been set, nuisance alarms will be reduced to an absolute minimum.

The following table gives suggested settings of ClassiFire alarm setting for different locations

Alarm Factor	Sensitivity	Probability of Nuisance Alarm	Suggested Protected Area
0	Extremely High	Once per year	Semiconductor manufacturing clean room
1		Once per 5 years	Computer room
2		Once per 10 years	Non-smoking office
3		Once per 50 years	Clean factory
4	Medium	Once per 1000 years	Warehouse
5	Medium	Once per 5,000 years	Warehouse with diesel trucks operating
6	Medium	Once per 10,000 years	Warehouse with diesel trucks operating
7	Low	Once per 20,000 years	Warehouse with diesel trucks operating
8	Low	Once per 100,000 years	Warehouse with diesel trucks operating

### 3.4.6 Hour start of day and night operation

**(Numeric - Address 001-127) Setup menu > Alarm levels**

These values are the times to the nearest hour at which the day/night switching is desired to take place on the detector. Entries are made in 24-hour format, e.g. **19:00** for 7pm. If no day/night switching is required, then both entries should be set to **00:00**. Day and night switching is intended so that the detector may automatically select a different sensitivity when the protected area is unoccupied and fewer contaminants are being produced. ClassiFire automatically detects the change in smoke level after the protected area is left, and if the time at which this happens is within +/- 70 minutes of the programmed switchover time it selects the night-time histogram. Note that if the environment actually becomes more contaminated during the night period for any reason then ClassiFire will adapt to that too, reducing the night-time sensitivity. The system will automatically compensate for 1 hour seasonal time-changes.

**NB** 

### 3.4.7 LDD™ Enable (Yes/No - Address 001-127)

**Setup menu > Alarm levels**

When this function is set to **Yes**, Laser Dust Discrimination (LDD) increases the response time of the detector slightly, whilst greatly reducing the likelihood of nuisance alarms due to dust ingress. LDD may be disabled in very clean rooms for a slightly faster response to smoke by setting this function to **No**. Disabling LDD is not recommended for areas other than manufacturing clean rooms, due to the increased probability of nuisance alarms in most other operating environments.

### 3.4.8 Start / Stop FastLearn (Yes/No - Address 001-127)

**Setup menu > Alarm levels**

If the detector is in FastLearn mode, setting this function to **No** will stop the FastLearn process. Using the function in this way is neither recommended nor supported by Kidde Products Ltd.

Setting this function to **Yes** will start a FastLearn at any time. The bargraph display on the front of the detector will show a rolling segment display on the front panel for the fifteen minutes that it takes to complete.

The text display will initially display the legend **FastLearn 15** and will then count down each minute until the FastLearn is complete.

It will take a further 24 hours after the FastLearn for full sensitivity to be reached, unless Demonstration Mode has been initiated. It is essential for proper functioning that the detector not be left in Demonstration mode, and that it be allowed to complete the 24-hour learning period. To cancel demo mode, set this function to **Yes** or power down and restart the detector to initiate FastLearn mode.



**IMPORTANT NOTE**

### **3.4.9 Auto FastLearn enable / disable (Yes/No - Address 001-127)**

#### **Setup menu > Alarm levels**

As default, this function is set to **Yes**. This ensures that if the detector is powered down for any reason (e.g. for maintenance or to be moved to a new area), a FastLearn is commenced automatically on power-up. There may be occasions when it is desirable to power down the detector for short periods of time, and it is highly likely that ambient contaminant levels will be the same on power-up. Under these circumstances it may not be desirable that the detector should go through the whole learning process again. To this end, this function can be set to **No** before power-down, where upon it will return to the original settings on power-up.

### **3.4.10 Time Delay Override (Yes/No - Address 001-127)**

#### **Setup menu > Alarm actions**

If this function is set to **Yes**, then the detector will ignore any pre-set time delays in the event of an unacceptably rapid increase in smoke density, thereby minimising response time to 'rapid growth' fires. This function would normally only be used where there were long time delays programmed on the alarm levels.

### **3.4.11 Cascading alarms (Yes/No - Address 001-127)**

#### **Setup menu > Alarm actions**

Setting this function to **Yes** means that only when the detector's controller has gone into Pre-Alarm does the controller start counting down the main Fire delay i.e. the time delays on Pre-Alarm and Fire 1 are cumulative. The Aux alarm is not included in the cumulative delay since it may be set to a higher level than either the Pre-Alarm or Fire 1 levels.

### **3.4.12 Latching alarms (Yes/No - Address 000-127)**

#### **Setup menu > Alarm actions**

When this function is set to **Yes** it requires a reset on the front panel or a remote reset to clear an alarm condition. It may be applied to the Command Module or a Standard Detector.



### **3.4.13 Latching faults (Yes/No - Address 000-127)**

**Setup menu > Alarm actions**

When this function is set to **Yes** it requires a reset from the front panel or a remote reset to clear fault indications. This is the factory default setting. It may be applied to the Command Module or a Standard Detector.

### **3.4.14 Remote day/night (Yes/No - Address 001-127)**

**Setup menu > Alarm actions**

Setting this function to **Yes** allows the detector to be manually switched between day and night mode using a remote input.

### **3.4.15 Remote reset enable (Yes/No - Address 000-127)**

**Setup menu > Alarm actions**

If remote resetting of the detector or Command Module is required from the host Fire Alarm controller or other external source, this option must be set to **Yes**.

### **3.4.16 Remote Isolate Enable (Yes/No - Address 000-127)**

**Setup menu > Alarm actions**

When this function is set to **Yes** a remote switch may be used to isolate the detector or Command Module.

### **3.4.17 Programmed Isolate (Yes/No - Address 000-127)**

**Setup menu > Alarm actions**

When set to **Yes** the controller will not generate alarms and will not indicate a fault condition on any fire panel which is connected, e.g. for use during detector maintenance. The 'Fault' light will be illuminated on the detector or Command Module front panel. The isolated condition will be disabled automatically after 7 days if not manually disabled.

### **3.4.18 Detector address / Number of detectors (Display - Address 000-127)**

**Setup menu > Detector**

In the case of the Standard Detector, this function displays the current address of the detector as set by the internal DIP switch. On the Command Module, it shows the number of detectors found on the communications loop. This function appears immediately on entering the **Detector** submenu. The Command Module is always at address '000'. When the Command Module unit is fitted in a detector, the detector must have a separate address.

### **3.4.19 Device Text (Alpha - Address 000-127)**

**Setup menu > Detector**

This is the default text string displayed on the Standard Detector or Command Module LCD display. If desired, this can be altered to any 16 character alphanumeric identification. Thus, for example, the name of the area being protected, or the name of the person responsible for fire safety could be entered. The default device text is **Stratos-HSSD 2** and the firmware revision level for the Standard Detector, and **Command Module** and the firmware revision level for the Command Module.

### **3.4.20 Reference device (Numeric - Address 001-127)**

**Setup menu > Reference**

Any detector on the loop may use another detector as a fresh air reference. When entering the **Reference** submenu the user is prompted to first select the address of the detector which will be using the reference, and is then forwarded to this option. To set a detector as a reference detector, enter its address as set by its internal DIP switch into this function.

### **3.4.21 Reference enable (Yes/No - Address 001-127)**

**Setup menu > Reference**

Setting this function to **Yes** enables the reference for the detector, if one has previously been allocated in **Reference device (1-127)** (see section 3.4.20, 'Reference device').

### **3.4.22 Reference level (Numeric - Address 001-127)**

**Setup menu > Reference**

The value set with this function is the percentage reference signal subtracted from the detector's signal, if a reference device has been allocated.

### **3.4.23 Back-off (Numeric - Address 001-127)**

**Setup menu > Reference**

This value is the delay time (in seconds) between a build up of pollution being seen by the reference (if used) and the pollution being seen by the detector.

### **3.4.24 Reset, Test & Isolate button enable/disable (Yes/No - Detectors 000-127)**

**Setup menu > Front panel**

The front panel buttons may be enabled or disabled individually for the Command Module or Standard Detectors by setting these functions to **Yes** or **No**.

### **3.4.25 Power save enable (Yes/No - Addresses 001-127)**

**Setup menu > Power checks**

This function allows the detector to minimise electrical power consumption when operating from stand-by batteries. If enabled, upon mains supply failure the aspirator will reduce speed to minimum, regardless of the user-defined value. This function may be disabled if the minimum aspirator speed increases transport time unacceptably. (See Section 3.4.28, "Aspirator speed").

**NB** 

When in this condition, any smoke reading above 3 bar graph segments on the detector will automatically remove this condition.

This function has no effect on the Command Module.

### **3.4.26 Battery check enable (Yes/No - Address 000-127)**

**Setup menu > Power checks**

If no battery back-up is required, this function should be set to **No** to avoid **Battery fault** being displayed on the front panel. If a back-up battery is used, it is recommended that the battery check be enabled. When this is done the user will be prompted for an input terminal to use. The battery fault will be displayed when this contact is open. The default setting is battery fault enabled on "I/P 1". Section 5.3.1 "Detector terminal block connections" and Section 5.3.2 "Command Module terminal block connections" show the input terminal connections for the Standard Detector and Command Module respectively.

### **3.4.27 Mains check enable (Yes/No - Address 000-127)**

**Setup menu > Power checks**

The Stratos-HSSD 2 detector and Command Module are capable of signalling power supply faults from the power supply where this is equipped with a fault relay (the power supply fitted by default has this feature). The mains check is disabled by default. If the user sets this function to Yes, the user will be prompted with an unassigned input terminal to use (this will normally be "I/P 2" if battery check is already enabled on "I/P 1" - see section 3.4.26, 'Battery check enable').

The mains fault will be displayed when this contact is open.

### **3.4.28 Aspirator speed (Numeric - Address 001-127)**

**Setup menu > Air flow**

The value entered sets the aspirator in the detector to one of a range of predetermined speeds. The lower the number entered the lower the airflow rate and the lower the power consumption.

### **3.4.29 Flow setup (Yes/No - Address 001-127)**

**Setup menu > Air flow**

Setting this function to **Yes** puts the detector into automatic flow limit setup mode. This takes a few minutes to set the flow fault thresholds based on the current flow rates.

### **3.4.30 Airflow monitoring (Display / Numeric - Address 001-127)**

**Setup menu > Air flow**

There are separate **Sensor pipe**, **Flow low**, **Flow high** and **Flow pipe** parameters for each pipe 1 to 4 on the detector. For example, **Flow pipe 1** indicates the current airflow rate for pipe 1.

**Sensor pipe 1** to **Sensor pipe 4** are used to enable or disable flow sensing on the specified pipe inlet of the detector. If any pipe inlets are unused, set the relevant flow sensor function for the pipe inlet to **No** to avoid unwanted flow faults.

**Flow low** is the level below which airflow needs to be reduced to trigger a fault reading (which may indicate a blocked pipe) and **Flow high** is the level above which airflow needs to increase to trigger a fault indication (which may indicate a loose or damaged inlet pipe).

**Flow low** and **Flow high** parameters are automatically set up on initial power-up or when **Flow setup** is selected (see section 3.4.29).

The airflow rates **Flow pipe 1** to **Flow pipe 4** are for display purposes only and cannot be changed.

### 3.4.31 Chart log recording rate (Numeric - Address 000-127)

Setup menu > Miscellaneous

This function controls how frequently the detector and alarm level or flow rates are stored in the Standard Detector or Command Module internal chart recorder log.

The chart log recording rates are as follows.

setting	type	storage interval	time per division on chart log
0	Detector output	1 second	10 seconds
1	Detector output	5 seconds	50 seconds
2	Detector output	12 seconds	2 minutes
3	Detector output	30 seconds	5 minutes
4	Detector output	1 minute	10 minutes
5	Detector output	2 minutes	20 minutes
6	Detector output	5 minutes	50 minutes
7	Detector output	10 minutes	100 minutes
8	Detector output	20 minutes	200 minutes
9	Detector output	50 minutes	500 minutes
10	flow recording	1 second	10 seconds
11	flow recording	5 seconds	50 seconds
12	flow recording	12 seconds	2 minutes
13	flow recording	30 seconds	5 minutes
14	flow recording	1 minute	10 minutes
15	flow recording	2 minutes	20 minutes
16	flow recording	5 minutes	50 minutes
17	flow recording	10 minutes	100 minutes
18	flow recording	20 minutes	200 minutes
19	flow recording	50 minutes	500 minutes

In the above table the greyed section indicates flow rate recording while the white section indicates detector and alarm level recording.

The factory default setting is 8. At the slowest recording rate, one month of data can be recorded. A PC must be connected via the RS232 port with appropriate software to view the chart recorder log. See section 8.5, "Connecting to a PC"

### 3.4.32 User defined access code (Numeric - Address 000-127)

Setup menu > Miscellaneous

This function sets the access code that the user has to input in order to modify any of the function values. The default setting is "0102" but for added security it can be changed to any four-digit number desired by the user.

### 3.4.33 BMS protocol (Numeric - CM only)

Setup menu > Miscellaneous

This function sets the communications protocol for connection to a Building Management System (BMS). Refer to Section 6, "External Communications" for details of these protocols.



### 3.4.34 Factory default (Yes/No - Address 000 - 127)

**Setup menu > Miscellaneous**

On the Standard Detector, this function has two purposes. If the user has changed any of the detector's functions, this function will display **No**, indicating that the detector is not at factory default. Setting the function to **Yes** will restore the detector to the factory default settings.

On the Command Module, this setting returns all detectors on the communications loop to their default settings. To default an individual detector in the loop, it is necessary to use the detector's own front panel.

### 3.4.35 Scan devices (Yes/No - CM only)

**Setup menu > Bus setup**

Setting this function to **Yes** causes the Command Module to scan the RS485 data bus for connected detectors. While scanning, the display will show **Scanning loop** and display a progress bar. When finished, the display will show the number of devices found and the detector addresses in the form.

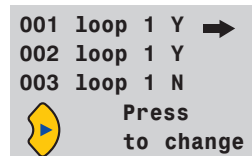

The list "wraps around", so that pressing **<up arrow>** when viewing Address 001 brings up detector number 127. Pressing **<right arrow>** allows the user to remove a detector address from the loop (by changing 'Y' to 'N'), or to re-instate a previously removed detector (by changing 'N' to 'Y'). This is different from the Isolate function in that a fault is still generated on the Command Module. However, this may need to be done if replacing a detector on the loop so that the detector's address becomes available to the replacement. After replacing the detector, the address may be re-enabled.

### 3.4.36 Looped bus (Yes/No - CM only)

**Setup menu > Bus setup**

This function is set to **Yes** to signify that the detectors are connected to the Command Module in a fault tolerant loop configuration (see section 8.2.1 for details). Failing to set this value to **Yes** for a loop configuration will mean that the fault monitoring advantages of the detector loop are lost. Setting the value to **Yes** for a non-fault tolerant configuration will generate detector loop errors, so it is important that the appropriate configuration is identified.

### 3.4.37 Poll timeout (Numeric - CM only)

**Setup menu > Bus setup**

This is the time, specified in milliseconds, which a device has to respond to a poll from the command module. If no response is received for this time then a **Comms fault** message is shown for this device on the Command Module display. This may be caused by communications delays, e.g. when units are communicating across a Wide Area Network. This function may then be set to a more suitable value.

NB: If in doubt about the setting of this function, please contact the Kidde Products Ltd. help line (see page 3).

### **3.4.38 Call centre (Numeric - CM only)**

**Setup menu > Pager**

This is the phone number the modem dials up to send a message. For further details on this and the other functions in the "Pager" submenu, see section 6.1.3, "Paging from the Command Module".

### **3.4.39 Password (Alpha - CM only)**

**Setup menu > Pager**

This is an optional password used to access the system.

### **3.4.40 Pager (Numeric - CM only)**

**Setup menu > Pager**

This is the number of the actual pager.

### **3.4.41 Page on fault (Yes/No - CM only)**

**Setup menu > Pager**

Where a pager has been allocated as above, this function determines whether the pager holder is to be paged when a fault condition is generated by the Command Module.

### **3.4.42 Page on alarm (Yes/No - CM only)**

**Setup menu > Pager**

Where a pager has been allocated as above, this function determines whether the pager holder is to be paged when a fire alarm condition is generated by the Command Module.

### **3.4.43 View event log (Display - Address 000-127)**

**Log menu**

This function shows the start and stop time and date of events such as FastLearn, alarm condition and error messages. The event log can also be downloaded to a PC via the RS232 serial port.

See section 7, "Event log" and section 8.5, "Connecting to a PC" for further details.

### **3.4.44 Diagnostics (Test - Address 001-127)**

**Diagnostic menu**

This function puts the detector into self-test mode. On a Command Module, it tests all detectors on the loop.

### **3.4.45 Detector read (Display - Address 001-127)**

#### **Diagnostic menu**

This function displays five values as shown: **009.47%**

**086 091 087 091**

The top value is the detector's current smoke level reading as a percentage of the full-scale value, and the bottom four readings are the current flow rates on each pipe as a percentage of the maximum possible flow rate.

### **3.4.46 Loop errors (Display)**

#### **Diagnostic menu**

This displays the percentage of loop errors in messages addressed to the detector or Command Module from the detector loop, along with a count of the number of received messages since the last message was received on port 1 and port 2 of the RS485 bus.

### **3.4.47 Dust separator condition (Display - Address 001-127)**

#### **Diagnostic menu**

The value given at this function is the efficiency rating of the dust separator element in the detector. A new element will give the reading **Separator 100.0%** in this function. When the efficiency has decreased to 80%, the Fault indicator LED will illuminate and the text display will show **Separator renew**.

If the separator is missing or improperly fitted the display will read **Separator change**.

**NB** 

Fitting a new element will automatically reset this figure to 100%.

See section 10, "Maintenance" for further details.

### **3.4.48 Relay tests (Test - Address 000-127)**

#### **Diagnostic menu**

This tests the connection of the Command Module or detector to an alarm panel by operating the alarm or fault relay currently selected. Assuming proper connection, this should give appropriate indications on the fire panel. The test runs through the sequence Aux ⇒ Pre-Alarm + Fault ⇒ Fire 1 + Fault ⇒ Fire 2 + Fault ⇒ Fault, stepping to the next test on the list when **<ENTER>** is pressed. Although the relevant relays are activated at each stage, the associated lights on the front panel are not illuminated or recorded in the event log.

### **3.4.49 Watchdog trip count (Display)**

#### **Diagnostic menu**

The watchdog is a circuit built into the controller that restarts the controller in the event of a failure to function properly. This could be as a result of electrical spikes. This count shows the number of interruptions found. The details of each problem can be found in the event log.

See 3.4.43, "Event log" and section 7 for further details.

### 3.5 Menu map

Menu	Submenu	Item	Para	
<b>MAIN MENU</b>	<b>Time and Date</b>	Time HH:MM <input type="checkbox"/>	3.4.1	
		Date DD/MM/YYYY		
	<b>Alarm levels</b>	Fire 2 level (1-25) <input type="checkbox"/>	3.4.2	
		Fire 1 level (8-10) <input type="checkbox"/>		
		Pre Alarm level (3-8) <input type="checkbox"/>	3.4.3	
		Aux level (2-10) <input type="checkbox"/>		
		Fire 2 delay (0-99) <input type="checkbox"/>	3.4.4	
		Fire 1 delay (0-60) <input type="checkbox"/>		
		Pre Alarm delay (0-60) <input type="checkbox"/>	3.4.5	
		Aux delay (0-60) <input type="checkbox"/>		
		Class. override (0-99) <input type="checkbox"/>	3.4.6	
		Alarm factor (0-5) <input type="checkbox"/>		
		Day start (0-23) <input type="checkbox"/>	3.4.7	
		Night start (0-23) <input type="checkbox"/>		
		LDD(TM) enable Enter Yes/No <input type="checkbox"/>	3.4.8	
		FastLearn start Enter Yes/No <input type="checkbox"/>		
		Auto FastLearn Enter Yes/No	3.4.9	
	<b>Setup Menu</b>	<b>Alarm actions</b>	Delay override Enter Yes/No <input type="checkbox"/>	3.4.10
			Cascading alarms Enter Yes/No <input type="checkbox"/>	3.4.11
			Latching alarms Enter Yes/No <input type="checkbox"/>	3.4.12
			Latching faults Enter Yes/No <input type="checkbox"/>	3.4.13
			Remote day/night Enter Yes/No <input type="checkbox"/>	3.4.14
			Remote reset Enter Yes/No <input type="checkbox"/>	3.4.15
			Remote isolate Enter Yes/No <input type="checkbox"/>	3.4.16
			Prog. Isolate on Enter Yes/No	3.4.17
			Detector address <input type="checkbox"/>	3.4.18
			Device text	3.4.19
			Reference enable Enter Yes/No <input type="checkbox"/>	3.4.20
			Reference device (1-127) <input type="checkbox"/>	3.4.21
			Level (0-99) <input type="checkbox"/>	3.4.22
			Back off (0-99)	3.4.23
			ISOLATE enable Enter Yes/No <input type="checkbox"/>	3.4.24
			TEST enable Enter Yes/No <input type="checkbox"/>	
			RESET enable Enter Yes/No	<input type="checkbox"/>
		Power save Enter Yes/No <input type="checkbox"/>	3.4.25	
		Battery check Enter Yes/No <input type="checkbox"/>	3.4.26	
		Mains check Enter Yes/No	3.4.27	
		Aspirator speed (1-16) <input type="checkbox"/>	3.4.28	
		Flow setup Enter Yes/No <input type="checkbox"/>	3.4.30	
		Sensor 'N' enable Enter Yes/No <input type="checkbox"/>		
		Flow pipe 'N' <input type="checkbox"/>		
		Flow low pipe 'N' (0-99) <input type="checkbox"/>		
		Flow high pipe 'N' (0-99)		
		Chart rate (0-5) <input type="checkbox"/>	3.4.31	
		Access code (0-9999) <input type="checkbox"/>	3.4.32	
		BMS protocol (0-2) (CM only) <input type="checkbox"/>	3.4.33	
		Factory default Enter Y/N	3.4.34	
		Bus setup (CM only)	Scan for devices Enter Yes/No <input type="checkbox"/>	3.4.35
			Numbers of detectors <input type="checkbox"/>	
		Looped bus Enter Yes/No <input type="checkbox"/>		
		Poll time out (30-255)	3.4.37	
	Pager (CM only)	Call centre <input type="checkbox"/>	3.4.38	
		Password <input type="checkbox"/>	3.4.39	
		Pager <input type="checkbox"/>	3.4.40	
		Page on fault Enter Yes/No <input type="checkbox"/>	3.4.41	
		Page on alarm Enter Yes/No	3.4.42	
<b>Log menu</b>	<b>View event log</b>		3.4.43	
<b>Diagnostic menu</b>	<b>Diagnostics</b>		3.4.44	
	<b>Detector read</b>		3.4.45	
	<b>Loop errors</b>		3.4.46	
	<b>Dust separators</b>		3.4.47	
	<b>Relay test</b>	Aux <input type="checkbox"/>	3.4.48	
		Pre Alarm+Fault <input type="checkbox"/>		
		Fire 1+Fault <input type="checkbox"/>		
	Fire 2+Fault <input type="checkbox"/>			
	Fault			
	<b>Watchdog count</b>		3.4.49	
<b>Reset</b>		<input type="checkbox"/>	3.2	
<b>Isolate</b>			3.2	
<b>Exit</b>			3.2	

This sequence is repeated for each  pipe 1-4 so that 'Flow high pipe 1' is  followed by 'Sensor 2 enable' etc.



## 4. Sampling Pipe Design

Aspirating system design is inherently simple. It is often possible to achieve good system performance with very simple installations. There are however a few rules which must be adhered to, and these rules are equally applicable to all aspirating systems which operate on similar principles to Stratos-HSSD. The information contained in this Handbook is intended as an overview only. For further information please see the complete System Design Guide.

1. Do not expect one detector to achieve good performance if sampling from areas of different air pressure (typically: underfloor air plenums and room spaces or different rooms in air-conditioned areas). This is because the air pressure differences may cause reverse or poor airflow along the sampling pipes. If it is not possible to locate the detector within the protected area it may be necessary to lead an exhaust pipe from the detector exhaust port returning air to the protected area.

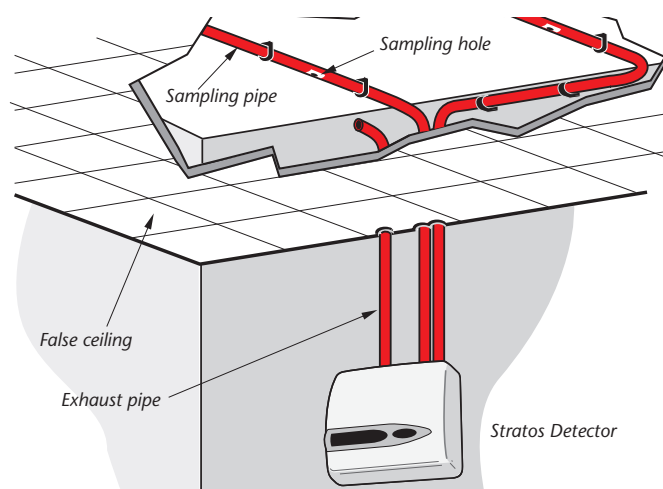

2. Always locate the sampling points in a position to which smoke may reasonably be expected to travel. This may sound obvious, but, for example, do not expect ceiling mounted sampling points to operate satisfactorily if air flow prevents the cool smoke from an incipient fire from reaching ceiling level. In this instance it is usually better to locate the sampling pipes directly in the airflow (for example in an air conditioning unit air intake). There is no substitute for carrying out smoke tests prior to installation of pipes to indicate suitable sampling point location.
3. To assist in design and to verify system performance, it is advisable to use the PipeCAD<sup>®</sup> sampling pipe modelling software.

### 4.1 Pipework

Sampling pipes should be made from a non-hazardous material and should be clearly identified.

- a. The ideal internal diameter of sampling pipes is 22mm. Other sizes will often work but will provide different response times.
- b. Ideally, if the total length of sampling pipe is greater than 50 metres, then multiple pipes should be used. When using multiple sampling pipes, care should be taken to achieve a reasonable degree of balance (say within 10% of airflow) to ensure even suction from the pipes.

- NB**  c. Maximum recommended total sampling pipe length is 200 metres. This is 4 lengths of 50 metres, or 2 lengths of 100 metres. In order for the installation to conform to EN54-20, pipes must conform at least to EN61386-1 Class 1131.
- d. Sampling pipes must have capped ends. The end cap should be drilled with a sampling hole normally between 4 or 5mm diameter and free from burrs. Sampling holes should normally be 3-4mm diameter or as calculated by PipeCAD and free from burrs. Each pipe run should not have more than 25 holes. Pipe transit time must not exceed 120 seconds and an approved type of pipe must be used for installations conforming to LPCB requirements. When drilling holes in the sample pipes, or cutting off lengths of pipe, ensure that all swarf and debris is removed from the pipe.

This guide holds true for average sampling pipe lengths, but if using long pipes (typically more than 60 metres total), performance may be improved by making the sampling holes near the ends slightly larger than those nearer the detector.

Although by no means essential, it must be recommended that if in doubt, PipeCAD® be used to ensure that transit times, balance of suction and individual sampling point sensitivity are within desired limits.

## 5. Installation

### 5.1 General

Before installing the detector the local standards for installation of aspirating detection systems must be consulted as these standards differ throughout the world. Specific advice for one country may not be applicable to another. The following is a brief set of guidelines on installing detectors.

- It is recommended that system design and installation is carried out by suitably experienced and trained personnel.
- The detector will normally be mounted at a level where there is easy access to the unit for configuration and programming.
- Unused sampling pipe inlets must be closed. For advice on pipe layout design consult the 'System Manual' and contact Kidde Products Ltd. help line (see page 3) in case of difficulty.
- The exhaust air from the unit must not be impeded in any way. If the unit is mounted in a different air pressure from where the air is being sampled (for example an air duct), then a pipe must be taken from the exhaust port back to the same air pressure zone as the sampling holes.
- All signal cables must be screened and must be of a suitable type. The specific type of cable will normally depend upon the local fire regulations.
- The unit must not be placed in areas where either the temperature or humidity is outside the specified operating range.
- The unit should not be placed in close proximity to any equipment expected to generate high Radio Frequency levels (such as radio alarms) or units generating high levels of electrical energy (such as large electric motors or generators).
- Ensure that when the detector is fitted to the wall there is enough space on the right hand side to allow removal and replacement of the filter element. (see section 10, 'Maintenance').

## 5.2 Mechanical installation

The detector body is fitted to a wall-mounting bracket which is attached to the wall via the mounting holes E as shown below. The detector is then fitted over the mounting stud D and secured inside the detector body with the nut provided for the purpose.

For a more discreet layout, it is possible to allow the sampling pipes and cables to enter the detector from the rear (see illustrations below), with the sample pipes and connection cables channelled into the wall. In order to achieve this, sampling holes A and B need to be opened up to a diameter of 30mm to take the sampling pipes (A) and the exhaust pipe (B). The holes C need to be opened up to 25mm diameter in order to take a suitable threaded metal cable gland to provide adequate RF screening for the connection cables. These modifications are shown in dotted lines below.

The wall will also need to be suitably prepared to allow the mounting plate to sit flush against the wall. The sampling and exhaust pipes must also extend out of the wall sufficiently to tightly engage in the pipe entries on the rear of the detector as shown. A good starting point would be 25mm of pipe extending past the back plate. If the detector then sits proud of the bracket, the pipe excess can be trimmed back in small increments until the correct fit is achieved.

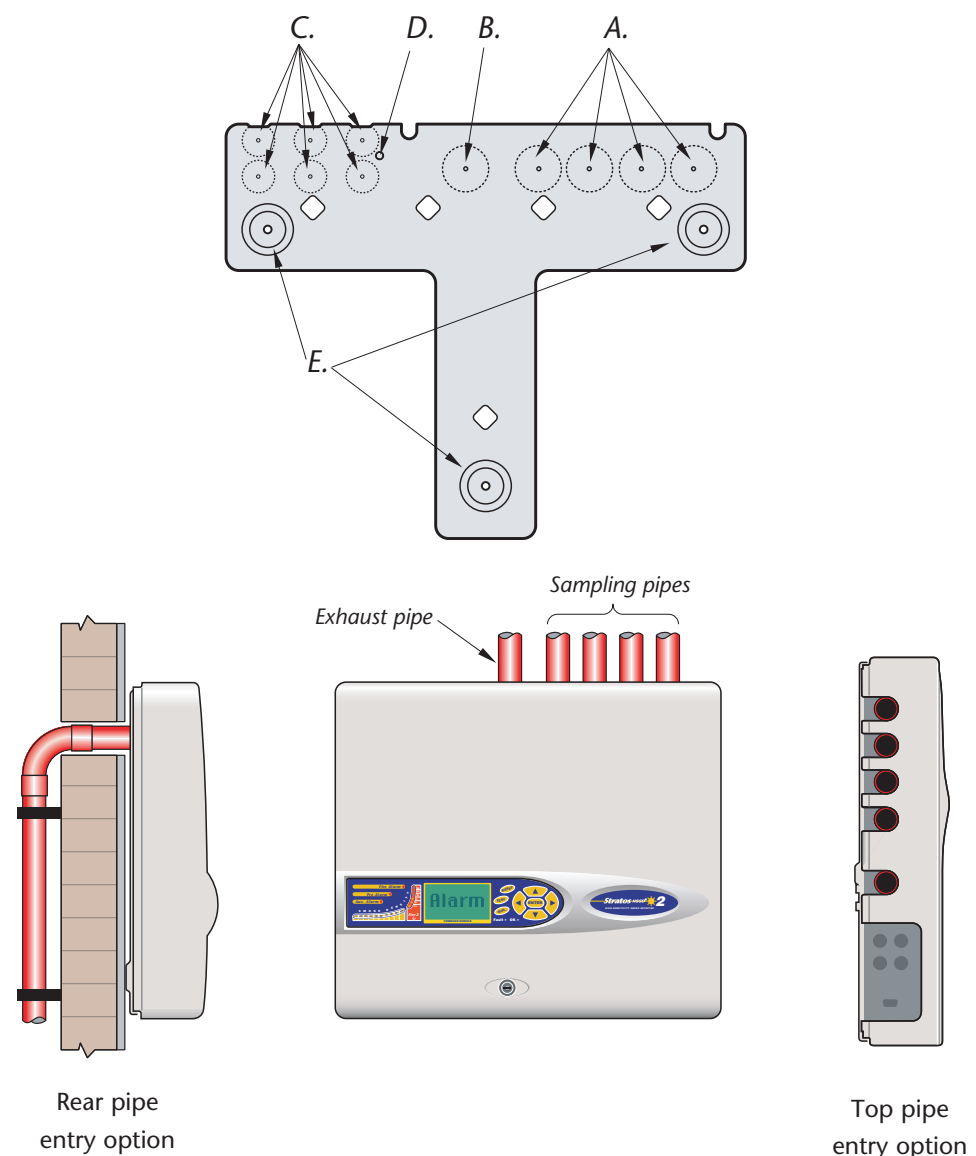

### 5.2.1 Removal and replacement of the detector front cover

To remove the front cover, unlock it using the key provided (turn anticlockwise). The bottom of the front cover may then be lifted away from the detector chassis until the top of the cover disengages from the retaining rails at the top of the chassis. The cover may then be removed.

If greater internal access is required, e.g. for software upgrades, it may be necessary to remove the LCD display board. To do this, unfasten the four counter-sunk crosshead screws holding the display to the display mounting brackets (NB, it is not necessary to remove the remaining four screws - see sections 1.3, 1.4, 1.5) and lift the display away from the main board. If the display needs to be completely removed, unplug the display ribbon connectors from the detector or Command Module main board, taking note of the position of the connectors which are as follows:

- For the Standard Detector, a single ribbon cable connected to the detector's 'Front Panel' display connector (see section 1.3)
- For the Command Module detector, a twin ribbon cable, one ribbon connected to the detector's 'Front Panel' display connector and marked 'DISPLAY DET', and one connected to the Command Module board's 'Commander Display' connector and marked 'DISPLAY COM' (see sections 1.3 and 1.4).
- For the stand-alone Command Module, a twin ribbon cable, one ribbon connected to the 'Detector Display' connector and marked 'COMMAND DET', and one connected to the 'Commander Display' connector and marked 'COMMAND COM' (see section 1.5).



When completely removing the display it is recommended that the ribbon connectors be removed from the main detector or Command Module board rather than from the display board. When removing these connectors, ensure that suitable antistatic precautions are taken, e.g. use of antistatic wrist straps, to prevent possible static damage to the unit's electronics. Refitting of the display is the reverse of the above procedure NB: ensure that the connectors are refitted as described above.

To refit the front cover, hook the recessed lip at the top of the front cover behind the two retaining guard rails at the top of the chassis like so:

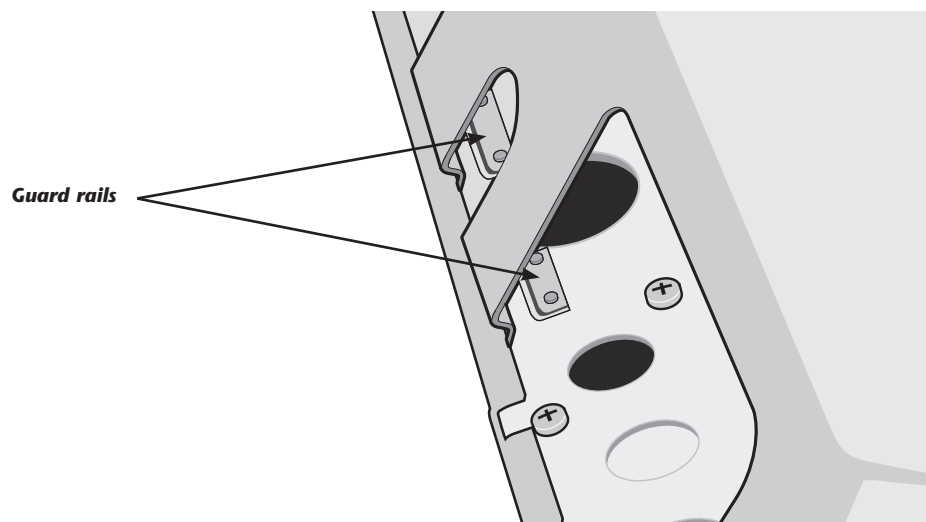

### 5.3 Electrical installation

All electrical (power and signal) connections should be made to the green terminal block inside the detector. Power cables should be screened and of sufficient current carrying capacity. Signal cable should be 120 screened twisted pair such as Belden 9841 24AWG. Power and signal cables should enter the detector via metal cable glands.

#### 5.3.1 Detector terminal block connections

Terminal block connections are as described below.

Remote input 1 Short pair to activate*	INPUT 1	BUSH 2	Addressable bus 2 high o/p <sup>†</sup>
		BUSL 2	Addressable bus 2 low o/p <sup>†</sup>
Remote input 2 Short pair to activate*	INPUT 2	BUSH 1	Addressable bus 1 high o/p <sup>†</sup>
		BUSL 1	Addressable bus 1 low o/p <sup>†</sup>
Remote input 3 Short pair to activate*	INPUT 3	SPARE	Spare
		SPARE	Spare
Spare	SPARE	SPARE	Spare
N/O Fire 2 contacts	FIRE 2	FIRE 2	N/O Fire 2 contacts
N/O Fire 1 contacts	FIRE 1	FIRE 1	N/O Fire 1 contacts
N/O Pre-Alarm contacts	PRE	PRE	N/O Pre-Alarm contacts
N/O Aux. contacts	AUX	AUX	N/O Aux contacts
N/C Fault contacts	FAULT	FAULT	N/C Fault contacts
Spare	SPARE		
RS485 bus 1 data line A	RS485 1A	RS485 2A	RS485 bus 2 data line A
RS485 bus 1 data line B	RS485 1B	RS485 2B	RS485 bus 2 data line B
RS485 bus 1 screen	SCREEN 1	SCREEN 2	RS485 bus 2 screen
		GND	

N/O = Normally open  
N/C = Normally closed

\* These connections can be used as the input terminals for mains supply and battery fault sensing. When this is the case, the contacts will signal a fault when the contacts are open rather than closed, as fault relays operate in the opposite sense to other relays, i.e. they are open for normal operation. The factory default setting is for supply monitoring on 'I/P 1'. If Input 1 is not being used for power supply monitoring, make sure that the Battery check function in the Remote software is not checked (off) for EN54-20 compliance. The Battery check function is located in the Function settings menu, Power monitoring tab.

† These connections are used to connect a detector to an addressable Fire Panel when a suitable Universal Addressable Interface card (see section 8.4) is fitted to the 'Addressable Interface connector on the left hand edge of the detector main PCB.

### 5.3.2 Command Module terminal block connections

All electrical (power and signal) connections should be made to the green terminal block inside the detector. Power cables should be screened and of sufficient current carrying capacity. Signal cable should be 120 screened twisted pair such as Belden 9841 24AWG. Power and signal cables should enter the detector via metal cable glands.

Terminal block connections are as described below.

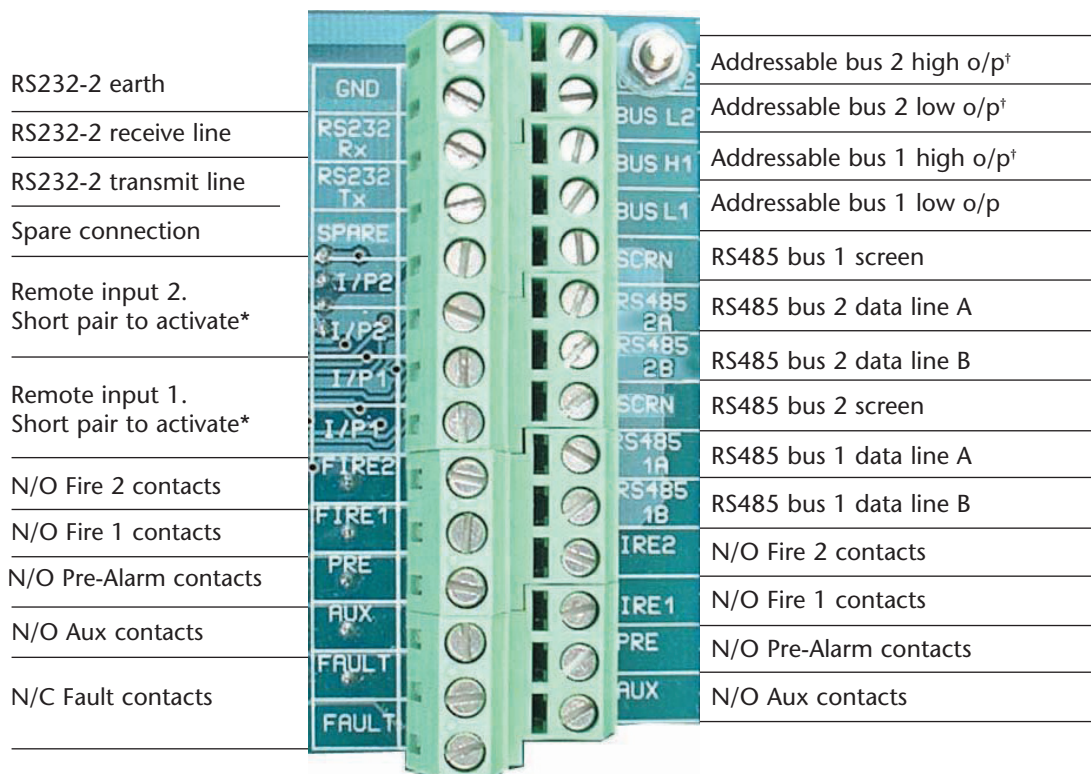

N/O = Normally open  
N/C = Normally closed

\* These connections can be used as the input terminals for mains supply and battery fault sensing. When this is the case, the contacts will signal a fault when the contacts are open rather than closed, as fault relays operate in the opposite sense to other relays, i.e. they are held closed during normal operation.  
The factory default setting is for supply monitoring on 'I/P 1'.

<sup>†</sup> These connections are used to connect a Command Module to an addressable Fire Panel when a suitable Universal Addressable Interface card (see section 8.3) is fitted to the 'Addressable Interface' connector on the left hand edge of the Command Module main PCB.



### 5.3.3 Connecting power cables

For the system to meet full EMC compliance requirements, the following precautions should be taken:

- Screened power cable should be used.
- The earth wire of power cables should be connected to the detector EARTH terminal, and this in turn connected to an earth stud on the detector chassis.
- All cables (power and signal) should pass through the screw-in metal cable glands provided. The screen of the power cable should be terminated at the cable gland.
- Power cables need to be fitted with a ferrite ring inside the detector case (2 off provided). The 24V and 0V wires should be long enough to form a loop around the ferrite wall.
- Separate wires from the power cables should be kept as short as possible, just enough to provide adequate stress relief.

Diagrams below show the appropriate arrangements for top and rear entry cables.

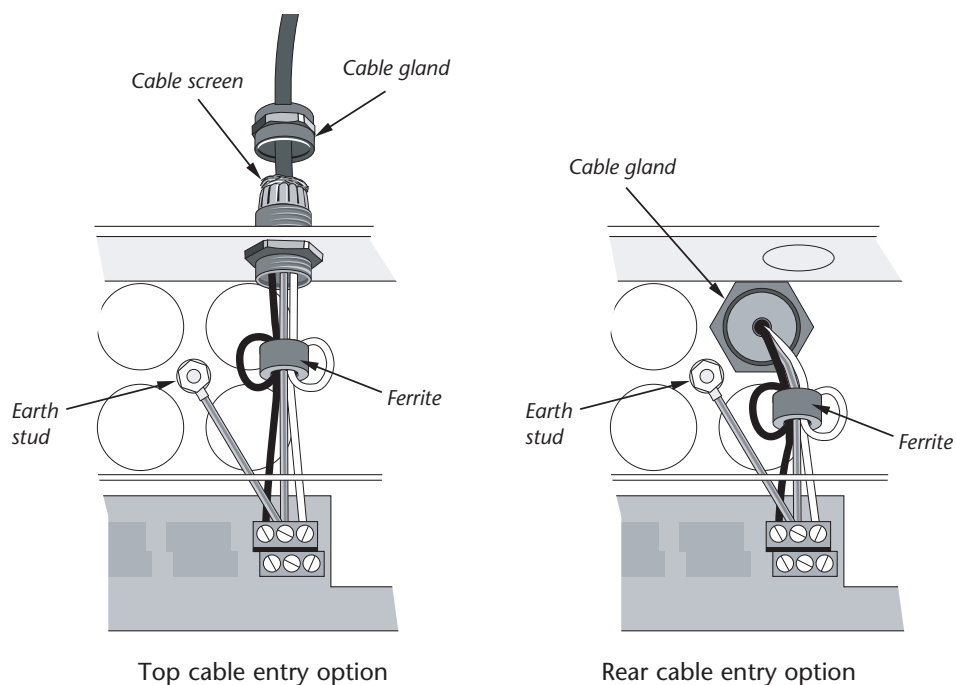

## 5.4 Power Supply Connections

The detector may be powered by any EN54-4 compliant monitored 24DC power supply of sufficient capacity.

### 5.4.1 Detector power supply connections

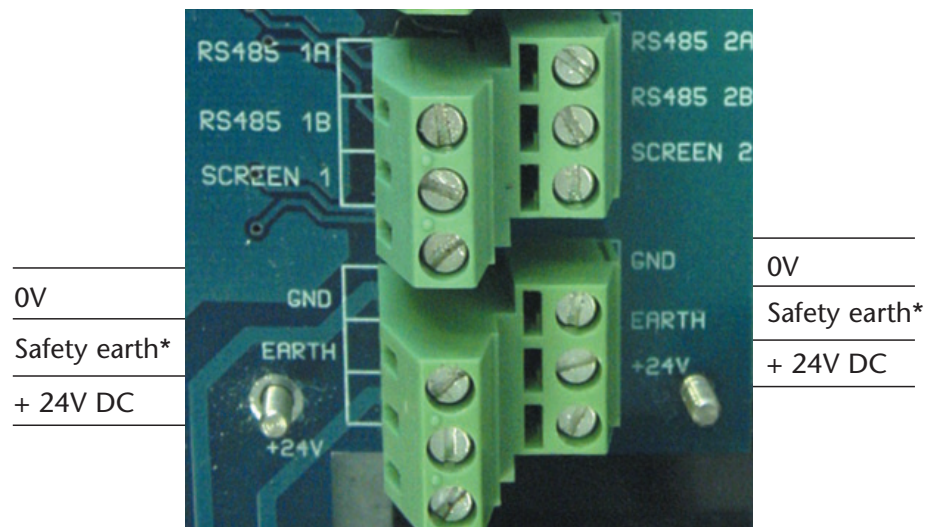

### 5.4.2 Command Module power supply connections

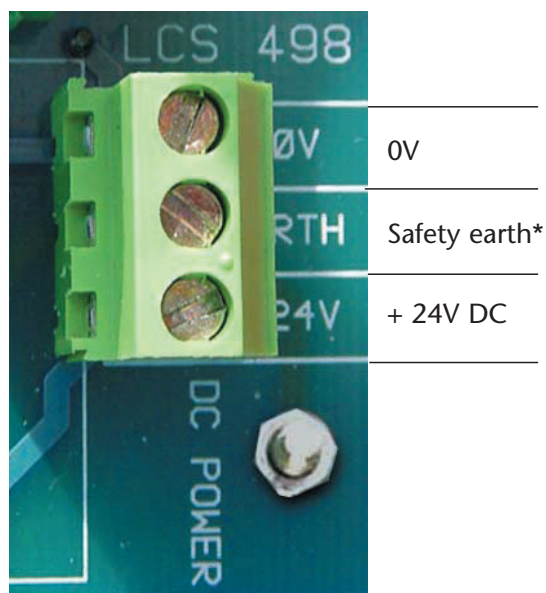

\*Note: the safety earth connection must be separate and not connected to the GND (ØV) connection.

### 5.4.3 Command Module internal power supply

The Command Module may be fitted with an integral power supply and battery charger. The relevant connections are shown below, although these will normally be made when the unit is manufactured. This diagram applies only to Command Modules fitted with an integral supply, although connections to alternative external power supplies will be similar.

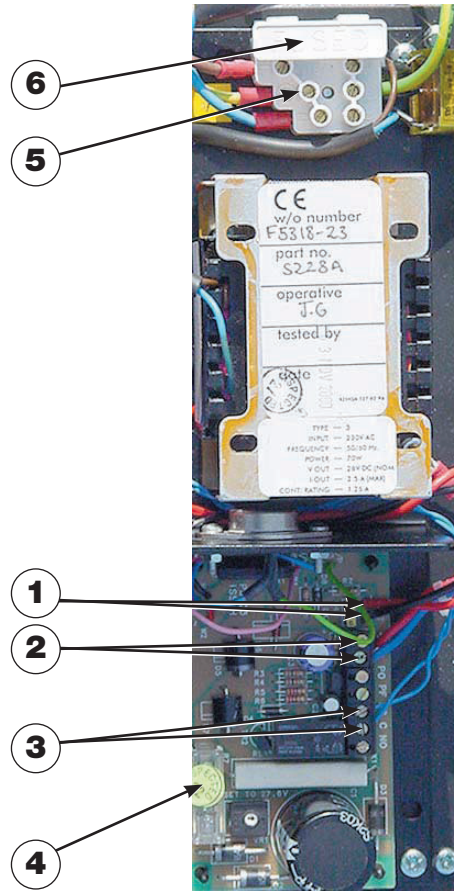

1. **BAT + and -** : battery recharge terminals. Bat + (red wire) goes to the positive terminal of the first battery and Bat - (black wire) to the negative terminal of the second battery. The negative terminal of the first battery is connected to the positive terminal of the second battery with the yellow cable supplied (see section 5.4.4, "Backup batteries").
2. **+ and -** : 24V DC supply connecting to the 24VDC and 0V terminals on the Command Module terminal block respectively (see section 5.4.2, "Command module power supply connections").
3. **NC and C** : Volt-free fault relay contacts to connect to the "I/P 1" or "I/P 2" terminals on the Command Module terminal block (see section 5.3.2, "Command module terminal block connections"). Polarity of the wires on these terminals is not important. See section 4.3.27, "Mains check enable"
4. **24V supply fuse**: 5 x 20mm 500mA type.
5. **Mains supply terminals**: This unit should only be powered by mains cable with an earth conductor. Connections are as follows:
  - Neutral (N): Blue wire (White in U.S)
  - Earth ( $\oplus$ ): Green and Yellow wire
  - Live (L): Brown wire (Black in U.S)
6. **Mains fuse**: For 230V operation, a standard 3A, 5 x 20mm mains fuse.

#### 5.4.4 Backup batteries

The Stratos-HSSD 2 Command Module can be fitted with 2 x 12V, 7 Ah backup batteries to give up to 24 hours' operation in the event of mains power failure. The integral battery charger can recharge the batteries to a minimum of 80% capacity within 24 hours of mains reconnection to comply with BS5839 and EN 54 part 4.

These fit under the covers immediately beneath the power supply, which are secured with four screws each. The batteries are fitted with the supply terminals to the left hand side as viewed from above, with the cut-out on the cover on the same side

To avoid current surge it is recommended that the batteries are fitted with the unit powered up.

Batteries are fitted as follows:

- Remove the battery covers.
- The positive terminal on the battery nearest the power supply is connected to the red wire from the power supply "BAT +" terminal (see section 5.4.3, "Command Module internal power supply").
- The negative terminal on the first battery is connected to the positive terminal on the second battery with the yellow battery interconnect wire supplied with the unit.
- The negative terminal on the second battery is connected to the black wire from the power supply "BAT –" terminal.
- Replace the battery covers after fitting the batteries.

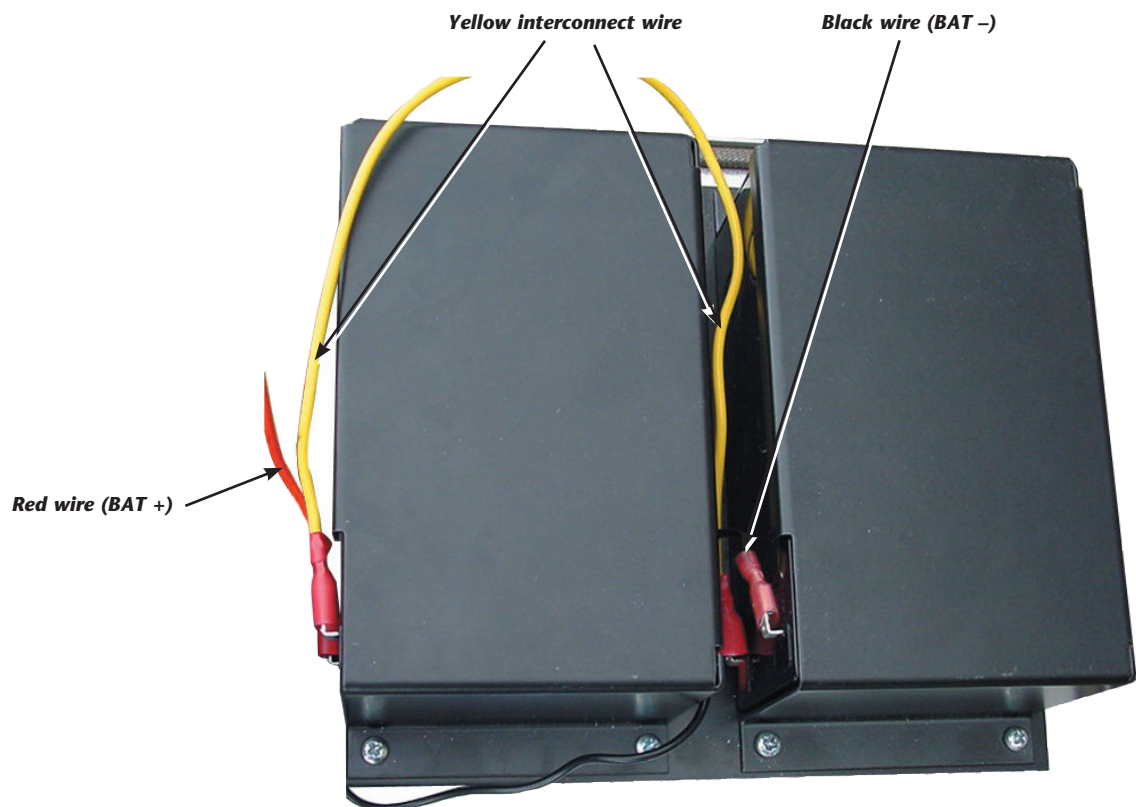

## 5.5 Demonstration Mode

In normal use, the detector remains in a reduced sensitivity mode for 24 hours whilst it gathers information about its environment. For purposes of demonstration, e.g. to verify a new installation, this may be disabled by putting the detector into "Demonstration Mode". This special operating mode bypasses the 24-hour learning process and allows the detector to operate at a high sensitivity after only 15 minutes learn time.

To enter Demonstration Mode, the detector must be in FastLearn mode. Whilst FastLearn is running, hold down the front panel <RESET> button and whilst holding this, simultaneously press the <TEST> and <ISOL> buttons. The <RESET> and <ISOL> buttons do not need to be enabled for this function.

When entering Demonstration Mode, the detector front panel LCD display will show the legend **Demo mode** and the time and date on which this was invoked.



### IMPORTANT NOTE

Demonstration Mode should only be used for demonstrations. It should not be used as a substitute for normal operation as the alarm settings in this mode are based solely on the sparse data gained during the 15-minute FastLearn period. Over time, this would lead to nuisance alarms due to normal variation in the detector's environment. To cancel Demonstration Mode, invoke a new FastLearn (see section 3.4.8).

## 5.6 EN54-20 compliance

The installation must be designed using PipeCAD software, which is provided free on the CD shipped with each detector. After designing the installation including pipes, endcaps and sampling holes, enter the detector type. To select the detector type, select Options, select Calculation options, and then select the detector from the Type drop-down list.

Select "Options" "Calculate" or click on the calculator icon. The software will prompt you to choose from "Use set hole sizes" "Best flow balance" and "Max. permissible transit time". Select the appropriate option and click "OK". The results for each pipe ("View" "Results") show calculations for each sampling hole on the pipe with the nearest to the detector at the top of the screen, and the endcap hole at the bottom.

For EN54-20 compliance the transport time of the last sampling hole shall be checked following all installation and proven to be less than or equal to that determined by PipeCAD.

The classification of each sampling device configuration and associated sensitivity settings are determined " by the column headed "Hole sensitivity % obs/m which shows the predicted sensitivity for each hole. For the installation to comply with EN54-20 depending on the class of installation, each sampling hole must be no less sensitive than the following:

Class A: 0.62% obs/m  
Class B: 1.95% obs/m  
Class C: 4.65% obs/m

The calculation can be further refined by leaving a working detector in the protected area for at least 24hrs at the intended alarm factor for the installation (this could be done before or after installation). The detector sensitivity can be read from the "Sensitivity" figure on the histogram screen of the Remote software supplied with each detector. Click "Options" and then click "Calculation options" to open the "Hole calculation options" dialog box. Enter the sensitivity value obtained from the practical test, and then click OK. The new calculated value will use the the real sensitivity from the practical test.

The PipeCAD software will determine the classification of any used configuration. Commissioning and periodic system tests must involve smoke tests to verify that the system performs as expected and enters Fire 1 alarm within the time determined by PipeCAD from the farthest hole. The detector sensitivity must also be inspected to ensure it has not radically fallen from the installed figure. If it has changed for any reason. the new figure must be re-entered into PipeCAD and the recalculated hole sensitivities must be confirmed to be within the class limits shown above.

The settings of a compliant system should be recorded, as it is possible by changing certain programmable functions to make the system non-compliant. If functions are changed, it is recommended that the system is retested if continuing compliance is in any doubt.



**IMPORTANT NOTE**

**For EN 54-20 compliant installations the detector requires that the flow thresholds be set manually to  $\pm 6\%$  of the nominal value, after the FastLearn phase is completed. For example, if the flow rate is 64% after the completion of the FastLearn period, the user must manually set the low flow threshold to 58% and the high flow threshold to 70%.**

## 6 External Communications

### 6.1 BMS protocols on the Stratos-HSSD 2 Command Module

The Command Module of the Stratos-HSSD 2 has a second RS232 port that can be used to send messages to a pager or compatible GSM phone using a modem or to enable connection to a Building Management System (BMS). This comprises the terminals "RS 232 Tx" (transmit), "RS 232 Rx" (receive) and "GND" on the green terminal block inside the unit (see section 5.3.2, Command Module terminal block connections").

Set-up of the Command Module is done using three functions; **BMS protocol**, **Page on fault** and **Page on alarm** (see sections 3.4.33, 3.4.41 and 3.4.42 respectively).

When either **Page on fault** or **Page on alarm** is enabled the second serial port is reserved exclusively for paging purposes by setting **BMS protocol** to 0 (TAP paging).

Programmable function **BMS protocol** sets the communications format that is used by the second serial port to communicate with the BMS. Setting **BMS protocol** to anything other than 0 (Tap paging) will disable functions **Page on fault** and **Page on alarm** if they are enabled.

BMS Protocol numbers are as follows:

protocol number	protocol
0	TAP paging (default).
1	Output only. Events are sent in the same Ascii text format as the internal event log display. This may be used to drive a serial printer if required.
2	BACnet ANSI/ASHRAE standard 135-1995.

#### 6.1.1 Text output support (protocol 1)

Text is output at 9600 baud, 8 bit with no parity. When an event occurs the event is printed in the following format:

```
Device      'Command Module' or 'Detector n'
Event      'Fire 1'
Timedate   10:32 21/03/2001
```



### **6.1.2 BACnet support (protocol 2)**

The Command Module models the attached detectors as analogue value object types instances 2 to 128. The Command Module status is stored as analogue value instance 1. The Present\_Value property of the analogue objects can have one of the following values; 0 = Disabled; 2 = Fault; 32 = Normal; 48 = PreAlarm; 64 = Fire 1; 128 = Fire 2.

The device object supports the following Properties:

Object\_Identifier  
Object\_Name  
Object\_Type  
System\_Status  
Vendor\_Name  
Vendor\_Identifier  
Model\_name  
Firmware\_Revision  
Application\_Software\_Version  
Protocol\_Version  
Protocol\_Conformance\_Class  
Protocol\_Services\_Supported  
Protocol\_Object\_Types\_Supported  
Max\_APDU\_Length\_Accepted  
Segmentation\_Supported  
APDU\_Timeout  
Number\_Of\_APDU\_Retries

The following Properties are supported by the analogue value objects:

Object\_Identifier  
Object\_Name  
Object\_Type  
Present\_Value  
Status\_Flags  
Event\_State  
Out\_Of\_Service  
Units

For further information on BACnet implementation, contact the Help Line. (see page 3)

### **6.1.3 Paging from the Command Module**

The Stratos-HSSD 2 Command Module has the facility to send text messages to alphanumeric pagers or SMS messages to some mobile phones.

In order to send messages to a pager or similar device a modem must be plugged into the RS232TX and RS232RX terminals of the Command Module using a suitable cable.

The call centres of the pager or SMS-capable phone must support the TAP protocol. In the UK Cellnet phones and BT pagers have this facility, amongst others. Please contact your pager provider to check whether they provide access with the TAP protocol.

### **6.1.4 Configuring the software**

No manual configuration of the modem is required as the command module configures the modem automatically on dialling.

The command module has three entries used to send messages. They are described below with an example for a BT pager. The functions may be found in **Setup menu** → **Pager**.

#### **Call centre**

This is the phone number the modem dials up to send a message. For the BT EasyReach service this number is 09011130000.

#### **Password**

This is an optional password used to access the system. BT EasyReach does not use the password so leave this entry blank.

#### **Pager**

This is the number of the actual pager. This number will be detailed in the pager or SMS phone documentation.

## **7. Event log**

An event is defined as operation of any of the front panel controls (when enabled), a signal received from a remote source (e.g. the Command Module or PC), a detector level exceeding the Aux., Pre-Alarm, Fire 1 or Fire 2 thresholds or certain commands sent from the remote software or SenseNET. The event log will also store items such as day and night start times, demonstration mode, power fault, detector fault etc. The detector keeps a log of the last 200 events for reference purposes.

The event log can be downloaded using a PC that has the remote software installed and is connected to the Stratos HSSD 2's RS 232 port using a serial cable. See section 8.5, 'Connecting to a PC'.

The event log can also be viewed in the **Log menu**, which prints out the event log in reverse order i.e. the last recorded event is printed out first.

When the buffer that stores events is full (200 events are stored) and a new event occurs, the oldest event in the buffer is discarded.

## 8. Interfacing

Because of the flexible nature of the Stratos-HSSD-2® detector and the many possible configurations, there are many options for interfacing the detectors to the Fire Panel. These include many third party interfaces available from various manufacturers. Because of this, it is not possible to give a complete list of all interfacing methods but the following pages will give details of the most common methods that are likely to be used.

### 8.1 Setting the detector address

In order to identify itself to the Command Module or fire panel, each detector needs to have a unique address ranging from 1 to 127. The detector address is simply set on the red DIP switch SW1 at the bottom left of the opened detector on the main circuit board. The switch settings are up for 1 and down for 0, and the detector address is set as a 7-bit binary code (switch 8 equates to a value of 128 and so is outside the usable address range). An example is shown below.

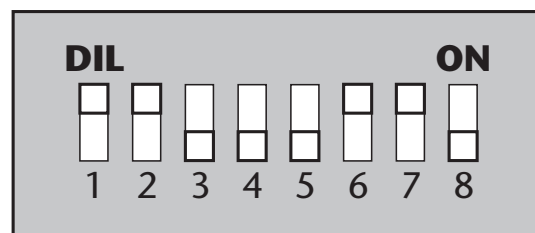

The address equates to 01100011 in binary, or  $(1 \times 1) + (1 \times 2) + (0 \times 4) + (0 \times 8) + (0 \times 16) + (1 \times 32) + (1 \times 64) + (0 \times 128) = 99$

The full range of available addresses and their relevant switch settings are in section 8.1.1 for reference.

### 8.1.1 Address table

Addresses chosen for detectors do not have to be consecutive or in a given order so long as they are all different.

ADDRESS	1	2	3	4	5	6	7	8
1	1	0	0	0	0	0	0	0
2	0	1	0	0	0	0	0	0
3	1	1	0	0	0	0	0	0
4	0	0	1	0	0	0	0	0
5	1	0	1	0	0	0	0	0
6	0	1	1	0	0	0	0	0
7	1	1	1	0	0	0	0	0
8	0	0	0	1	0	0	0	0
9	1	0	0	1	0	0	0	0
10	0	1	0	1	0	0	0	0
11	1	1	0	1	0	0	0	0
12	0	0	1	1	0	0	0	0
13	1	0	1	1	0	0	0	0
14	0	1	1	1	0	0	0	0
15	1	1	1	1	0	0	0	0
16	0	0	0	0	1	0	0	0
17	1	0	0	0	1	0	0	0
18	0	1	0	0	1	0	0	0
19	1	1	0	0	1	0	0	0
20	0	0	1	0	1	0	0	0
21	1	0	1	0	1	0	0	0
22	0	1	1	0	1	0	0	0
23	1	1	1	0	1	0	0	0
24	0	0	0	1	1	0	0	0
25	1	0	0	1	1	0	0	0
26	0	1	0	1	1	0	0	0
27	1	1	0	1	1	0	0	0
28	0	0	1	1	1	0	0	0
29	1	0	1	1	1	0	0	0
30	0	1	1	1	1	0	0	0
31	1	1	1	1	1	0	0	0
32	0	0	0	0	0	1	0	0
33	1	0	0	0	0	1	0	0
34	0	1	0	0	0	1	0	0
35	1	1	0	0	0	1	0	0
36	0	0	1	0	0	1	0	0
37	1	0	1	0	0	1	0	0
38	0	1	1	0	0	1	0	0
39	1	1	1	0	0	1	0	0
40	0	0	0	1	0	1	0	0
41	1	0	0	1	0	1	0	0
42	0	1	0	1	0	1	0	0
43	1	1	0	1	0	1	0	0
44	0	0	1	1	0	1	0	0
45	1	0	1	1	0	1	0	0
46	0	1	1	1	0	1	0	0
47	1	1	1	1	0	1	0	0
48	0	0	0	0	1	1	0	0
49	1	0	0	0	1	1	0	0
50	0	1	0	0	1	1	0	0
51	1	1	0	0	1	1	0	0
52	0	0	1	0	1	1	0	0
53	1	0	1	0	1	1	0	0
54	0	1	1	0	1	1	0	0
55	1	1	1	0	1	1	0	0
56	0	0	0	1	1	1	0	0
57	1	0	0	1	1	1	0	0
58	0	1	0	1	1	1	0	0
59	1	1	0	1	1	1	0	0
60	0	0	1	1	1	1	0	0
61	1	0	1	1	1	1	0	0
62	0	1	1	1	1	1	0	0
63	1	1	1	1	1	1	0	0
64	0	0	0	0	0	0	1	0

65	1	0	0	0	0	0	1	0	
66	0	1	0	0	0	0	1	0	
67	1	1	0	0	0	0	1	0	
68	0	0	1	0	0	0	1	0	
69	1	0	1	0	0	0	1	0	
70	0	1	1	0	0	0	1	0	
71	1	1	1	0	0	0	1	0	
72	0	0	0	1	0	0	1	0	
73	1	0	0	1	0	0	1	0	
74	0	1	0	1	0	0	1	0	
75	1	1	0	1	0	0	1	0	
76	0	0	1	1	0	0	1	0	
77	1	0	1	1	0	0	1	0	
78	0	1	1	1	0	0	1	0	
79	1	1	1	1	0	0	1	0	
80	0	0	0	1	0	1	0	1	0
81	1	0	0	0	1	0	1	0	
82	0	1	0	0	1	0	1	0	
83	1	1	0	0	1	0	1	0	
84	0	0	1	0	1	0	1	0	
85	1	0	1	0	1	0	1	0	
86	0	1	1	0	1	0	1	0	
87	1	1	1	0	1	0	1	0	
88	0	0	0	1	1	0	1	0	
89	1	0	0	1	1	0	1	0	
90	0	1	0	1	1	0	1	0	
91	1	1	0	1	1	0	1	0	
92	0	0	1	1	1	0	1	0	
93	1	0	1	1	1	0	1	0	
94	0	1	1	1	1	0	1	0	
95	1	1	1	1	1	0	1	0	
96	0	0	0	0	0	1	1	0	
97	1	0	0	0	0	1	1	0	
98	0	1	0	0	0	1	1	0	
99	1	1	0	0	0	1	1	0	
100	0	0	1	0	0	1	1	0	
101	1	0	1	0	0	1	1	0	
102	0	1	1	0	0	1	1	0	
103	1	1	1	0	0	1	1	0	
104	0	0	0	1	0	1	1	0	
105	1	0	0	1	0	1	1	0	
106	0	1	0	1	0	1	1	0	
107	1	1	0	1	0	1	1	0	
108	0	0	1	1	0	1	1	0	
109	1	0	1	1	0	1	1	0	
110	0	1	1	1	0	1	1	0	
111	1	1	1	1	0	1	1	0	
112	0	0	0	0	1	1	1	0	
113	1	0	0	0	1	1	1	0	
114	0	1	0	0	1	1	1	0	
115	1	1	0	0	1	1	1	0	
116	0	0	1	0	1	1	1	0	
117	1	0	1	0	1	1	1	0	
118	0	1	1	0	1	1	1	0	
119	1	1	1	0	1	1	1	0	
120	0	0	0	1	1	1	1	0	
121	1	0	0	1	1	1	1	0	
122	0	1	0	1	1	1	1	0	
123	1	1	0	1	1	1	1	0	
124	0	0	1	1	1	1	1	0	
125	1	0	1	1	1	1	1	0	
126	0	1	1	1	1	1	1	0	
127	1	1	1	1	1	1	1	0	

## 8.2 Connecting a detector network to a command module

120 ohm screened twisted pair such as Belden 9841 24 AWG should be used for all loop connections. The RS485 A and B wires should be taken through a ferrite (supplied) with a single loop illustrated for the power wires in section 5.3.3. The total length of interconnecting cable between adjacent Stratos-HSSD 2 detectors in the loop should not exceed 1.2 kilometres.

The detectors are connected using the RS485 connections on the terminal block (see sections 5.3.1/5.3.2) RS485 1A and 1B are the signal connections for bus 1 and RS485 2A and 2B are the signal connections for bus 2. SCREEN 1 and 2 are the screen connections for buses 1 and 2 respectively.

For the Command Module, the RS485 1A and 1B connections may be thought of as the 'Send' lines, and 2A and 2B the 'Return' lines. For each detector on the loop, the 1A and 1B connections may be thought of as the lines from the previous detector on the loop and the 2A and 2B connections the lines to the next detector in the loop.

### 8.2.1 Fault tolerant detector loop configuration

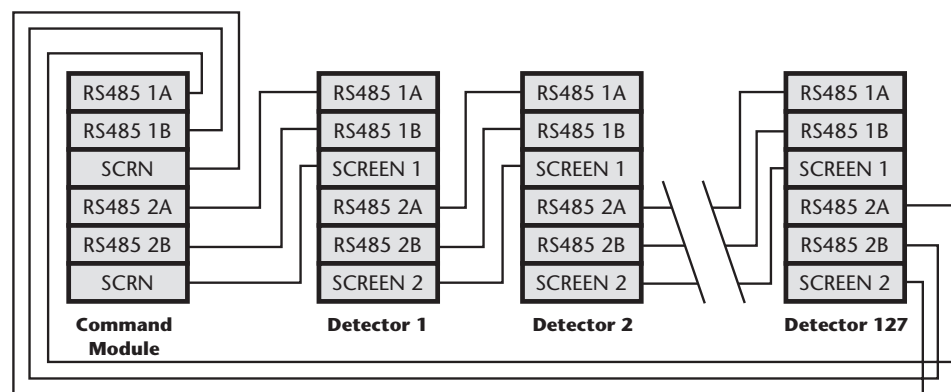

It should be pointed out that loop connections such as above are only needed for a fully fault-tolerant network where full isolation is required between detectors. If all detectors are operating within the same zone a series connection can be used where the output from the Command Module is taken from the Bus 2 terminals and the last detector in the loop does not require to be connected back to the command module as shown below. In this example, the Command Module will not be able to monitor the network for communications problems but less wiring is required.

### 8.2.2 Non-fault tolerant serial configuration

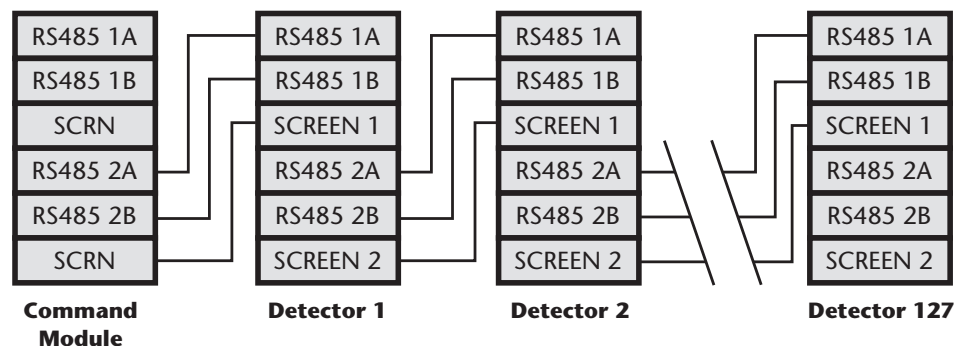

### 8.3 Connecting a Command Module to an addressable Fire Panel

When a Command Module is being used to manage one or more detectors (the maximum limit is 127) then a Addressable Protocol Interface Card (APIC) may be used to decode detector status information in the Command Module and relay to the the Fire Panel via the Addressable Bus 1 and Bus 2 terminal block connections (see section 5.3.2 'Command Module terminal block connections'). In this configuration only one interface is required and all detector information is available through this interface, one address per device.

Note: some addressable protocols may limit the maximum number of device addresses to less than 127. The detector address on the SenseNET loop and the Fire Panel addressable protocol address are the same i.e. no address translation is performed. Some protocols may not support all of the available alarm levels and fault reporting is usually a general fault with no detailed fault information.

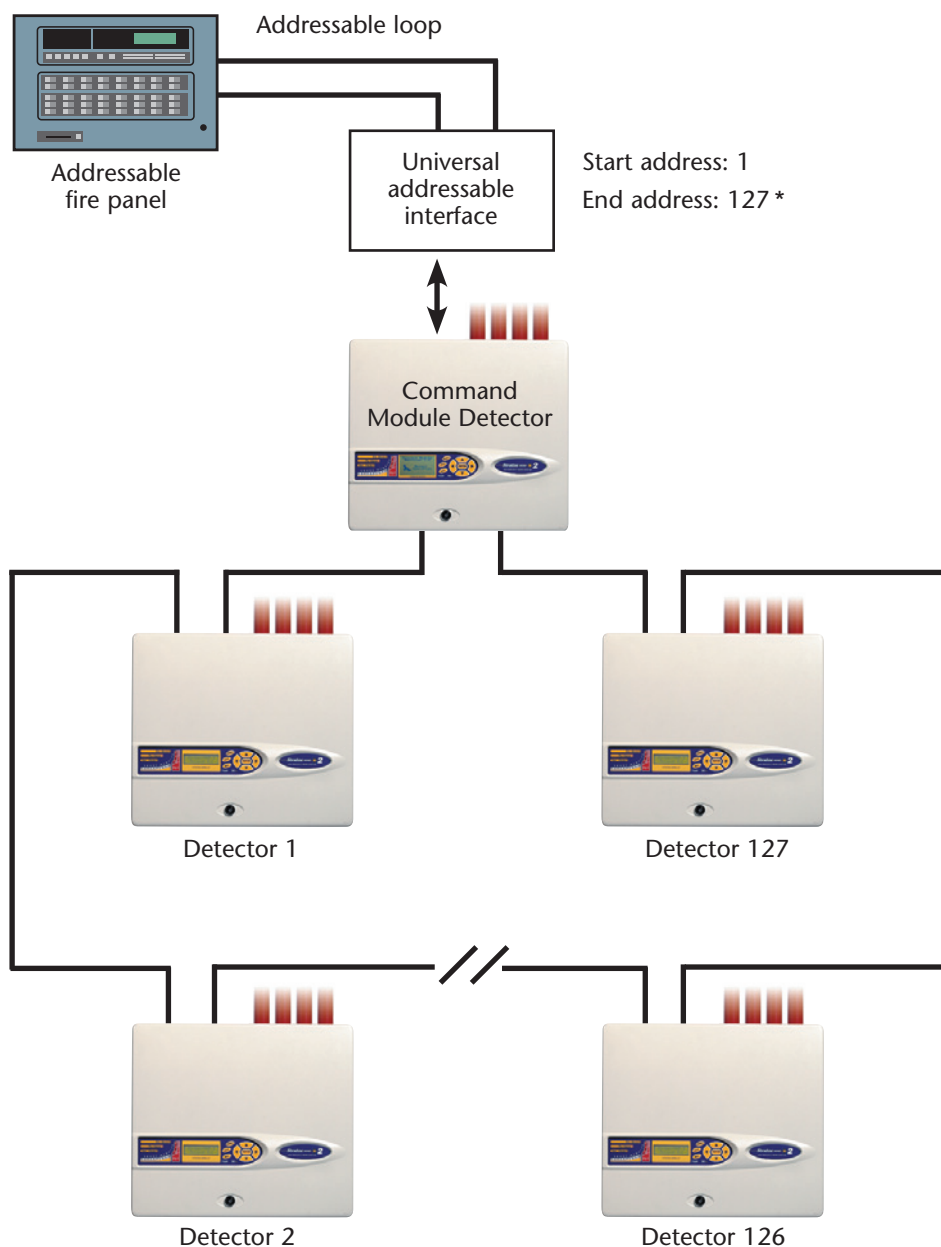

\*It is not essential in networks of less than 127 detectors that a continuous unbroken range of detector addresses is used, merely that all addresses are different and that the full range of addresses is set on the APIC. However, any unused addresses would then show up on the fire panel as in fault (detector not present). It is therefore recommended that, when using a UAI to communicate to a fire panel, an unbroken range of detector addresses is employed.



### 8.4 Connecting a single Stratos-HSSD-2 to an addressable Fire Panel

An APIC may be used to decode detector status information and relay this to the Fire Panel via the Addressable Bus 1 and Bus 2 terminal block connections (see section 5.3.1 'Detector terminal block connections').

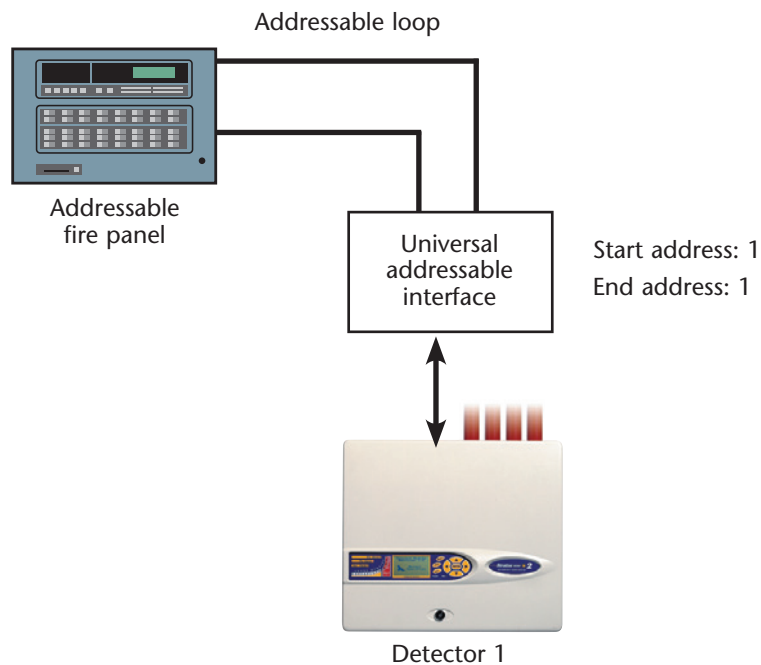

**NB** Note: The detector address on the RS485 communications loop and the Fire Panel addressable protocol address are the same i.e. no address translation is performed. Some protocols may not support all of the available alarm levels and fault reporting is usually a general fault with no detailed fault information.

### 8.5 Connecting to a PC

To connect a single stand-alone detector to a PC, connect the PC's serial port directly to the detector's 9-way RS232 port. Connections for this cable are shown below.

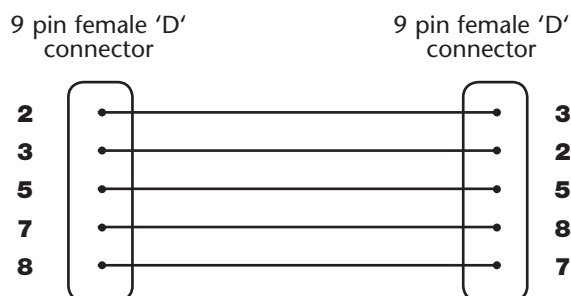

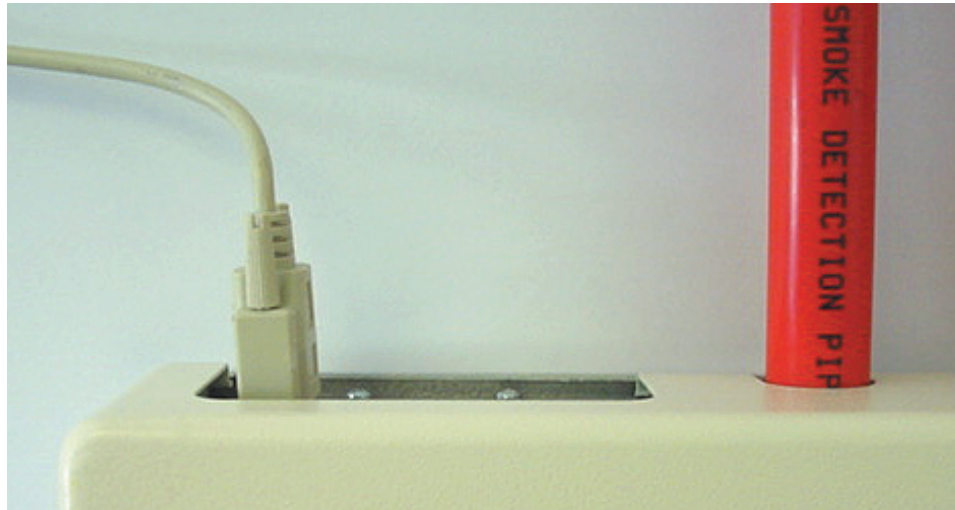

When multiple detectors are networked together and a Command Module is being used, the PC connects to the Command Module's 9-way RS232 port. The cable connections are the same as the Standard Detector cable connections.

## 9. Commissioning

Before commissioning the detector the local standards of aspirating detection systems must be consulted. These standards differ widely throughout the world and specific advice for the market in one country may not be applicable to another.

Commissioning strategy will initially depend upon the environment in which the detector is installed. For instance, the test for a computer room (which should be a relatively clean environment) would be very different from, say, a flour mill, which would probably have a high level of airborne particulate content.

A widely accepted standard for computer rooms/EDP areas is British Standard BS6266, equipment overheating at a stage well before combustion. To perform the test electrically overload a 1 metre length of PVC insulated wire of 10/0.1mm gauge for one minute using an appropriate power supply. The detector has two minutes from the end of the wire burn to give an alarm indication.

For areas with higher levels of background particulate matter testing methodology would be similar to that of standard point detectors.

## 9.1 Commissioning checklist

The following brief checklist allows quick setup of the detector. This procedure will be adequate for most standard installations.



### IMPORTANT NOTE

1. Before powering up the detector, visually check all cabling to ensure correct connection. If wire identification is not immediately clear (e.g. by use of different coloured wires or wire identification sleeves) an electrical check should be made. Any damage caused by misconnection of the detector is not covered by warranty.
2. Power up the unit and enter the engineering access code. The factory default setting for this is **0102**. See section 3.1 'Engineering access code' for further details.
3. Enter the **Setup menu** and verify that the time and date are correct. (see section 3.4.1)
4. Set an appropriate alarm factor for the protected environment. The detector will perform a FastLearn for the new alarm factor. (see section 3.4.5)
5. Whilst the detector is still in FastLearn mode exit the program mode on the display by pressing **<RESET>** and set the detector into demonstration mode (see section 5.5). To do this, press and hold down the **<RESET>** button and simultaneously depress the **<TEST>** and **<ISOL>** buttons. The text display will then display **Demo mode** and the time and date.
6. Wait for the FastLearn to finish (when the legend **FastLearn end** will appear on the display and the 'rolling' LED indications will finish) and perform any necessary smoke tests, ensuring that the detector reacts appropriately, and let the smoke fully dissipate.
7. Perform another FastLearn, this time not putting the detector into demonstration mode. The detector will generate no alarms during the 15 minute FastLearn period, and after this the detector will operate at a reduced sensitivity for 24 hours whilst ClassiFire acclimatises to the protected environment and sets up appropriate day and night sensitivity settings.

## 10. Maintenance

Stratos-HSSD is a very low maintenance detection system. If required, external cleaning of the unit should be performed using a damp (not wet) cloth. Do not use solvents as these may mar the display bezel. The only part that may require field replacement during servicing is the dust separator assembly. The dust separator condition can be checked using the **Dust Separator** test in the **Diagnostics menu**, which gives a percentage reading of dust separator efficiency. When this level drops to 80% the detector will signal a **Separator renew** fault and the dust separator will need replacing. See section 3.4.38

As dust contained in the dust separators may expose maintenance personnel to a 'Nuisance Dust' hazard as defined by the 'Control of Substances Hazardous to Health' (COSHH), it is strongly recommended that suitable masks and protective clothing be worn when changing filters. Used separators are not intended for re-use and should be disposed of.

The following illustration shows how the dust separator is replaced. Make sure to push the separator fully home, or the detector will fail to register its presence, and will continue to indicate **Separator change**.

Open the front cover using the key provided, and locate the dust separator tab at the bottom right of the detector as shown. Remove the black end piece with the removal tab from the filter element and dispose of the element. Fit the new element into the plastic end piece and slide into the detector. The filter should be fitted with the legend 'IN' towards the front of the detector. If the filter is inserted the wrong way up, the detector will not register its presence and the **Separator change** legend will stay on the display. When the replacement filter is fitted, the detector will automatically start a FastLearn routine.

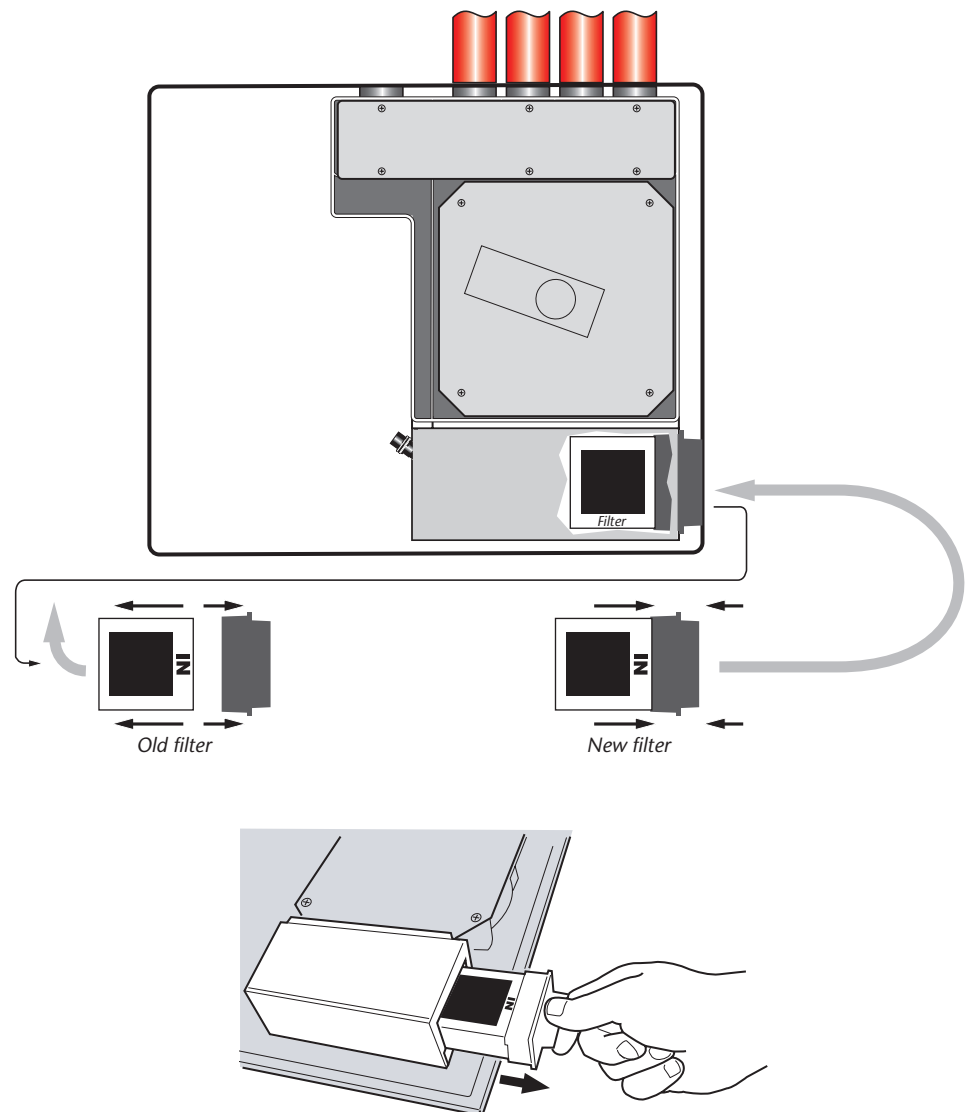

## 11. Troubleshooting **11.1 Pressing RESET or ISOL. button has no effect**

- Check that the controls have been enabled. These functions are disabled by default. See section 3.4.24

### **11.2 Nuisance alarms occur too often**

- Check that the ClassiFire alarm factor setting is appropriate for the normal working environment of the protected area. See section 3.4.5
- Check that the detector is not in Demonstration mode. This can be ascertained by viewing the event log (see sections 3.4.43 and 7) and checking that the entry **Demo mode** has a higher log entry number than the most recent **FastLearn start** and **FastLearn end** entries. Remember that the log entries are in reverse order, with the most recent entries appearing first.

If the log shows that Demonstration mode was invoked during the last FastLearn period, start a new FastLearn and allow it to complete its 24-hour cycle. (See section 3.4.8)

- From the event log (see sections 3.4.43 and 7), check that 24 hours have elapsed since the last **FastLearn end** entry.
- Check that day-night switchover times are appropriately set to reflect active and non-active periods (see section 3.4.6).

### **11.3 Elevated smoke levels do not generate alarms**

- Check that detector is not Isolated or in FastLearn (if Isolated, the Fault light will be lit)
- Check that the detector sampling points are in the smoke stream
- Check that unused sampling pipe ports are closed and that sampling pipes are firmly and cleanly seated in their ports and undamaged
- Check that the correct ClassiFire alarm setting has been set (see section 3.4.5)
- Check that the detector has either had a 24 hour learning period or that it has been placed in demonstration mode.

### **11.4 Low mean output**

- Check that the filter does not require changing (see section 3.4.47) and that the air plenum chamber is clean. The chamber may become clogged when, for example, heavy building activity has occurred near the sampling pipes. If so, the chamber may require factory service. The detector is not designed to handle large quantities of coarse debris and dust.

### **11.5 Detector sensitivity varies over time**

- There are many reasons why particle densities may vary, and the ClassiFire system automatically compensates for this in order to replace the likelihood of nuisance alarms due to normal variations in background smoke density. Within limits set by the ClassiFire alarm factor, this is a normal part of the detector's working.

## **11.6 Flow fault errors**

- These occur when the airflow rate into the detector exceeds the pre-programmed parameters. As the detector 'learns' the flow setup from the initial installation, this usually means that there has been some change in conditions. A **Flow high** fault may indicate that a sampling pipe is damaged, and a **Flow low** fault may indicate that the pipe has been blocked, e.g. by nearby building operations.
- If the detector input is sampled from one area and the exhaust is in another area with different pressure (e.g. the detector is in a roof space and sampling from an enclosed room), this may lead to flow faults. In this case it would be necessary to lead a pipe from the exhaust to the protected area to ensure nominal flow.

### **11.6.1 "Low flow" error messages.**

- Check that the pipe giving the error is not blocked
- Check that, if the pipe is unused, the flow sensor for this pipe has been disabled (see section 3.4.30)
- Check that the low flow fault threshold is not set too high (see section 3.4.30)
- Consider increasing the aspirator (fan) speed (see section 3.4.28)

### **11.6.2 "High flow" error messages**

- Check that the pipe is pushed home into the inlet and is not broken or cracked
- Check that installed pipework is fitted with an endcap.  
PipeCAD<sup>®</sup> pipe modelling software prompts the use of appropriate endcaps. Open bore pipes are not recommended.
- Check that the high flow fault threshold is not set too low (see section 3.4.30)
- Consider reducing the aspirator (fan) speed (see section 3.4.28).

## **11.7 Cannot refit the front cover**

- Check that the recessed top edge of the cover is securely located behind the locating guard rails on the chassis (see section 5.2.1).
- Check that the key is turned to the unlocked position (anticlockwise)

## **11.8 No display**

- Check that the display ribbon cable is securely connected to the detector/command module main board and to the display board as appropriate. (see section 5.2.1)
- Check that the display ribbon cable has not been damaged.



The Stratos-HSSD-2 text display can provide a wide range of information about the detector. A list of error messages follows with a brief explanation of their meanings.

**Separator renew** : The dust separator requires replacement. See section 10, 'Maintenance'

**Separator change** : The dust separator is missing or improperly fitted. See section 10, 'Maintenance'

**Bad value, Bad time, Bad date** : A value has been input into a function, which is outside the parameter range for that value. Take note of the range of values allowed (in brackets) and try again.

**Bad detector** : A detector address has been entered which is either outside the allowed range or which is not present on the loop. This may also happen if the user has entered address 000 (command module) for a function which it does not support (e.g. alarm factor)

**No response** : The Command Module has unsuccessfully attempted to read a function value from a connected unit. Check that the unit connected supports this function.

**001 X 002**

**Loop break** : There is a break in the communications loop between the detector addresses specified. Check the wiring.

**Comms fault** : The Command Module has polled a detector and no response has been received after the specified poll timeout value. (see section 3.4.37)

**Bad access code** : An incorrect access code has been entered. Enter the correct code.

**Battery fault** : This indicates either that the standby battery has discharged to a predetermined level or that no standby battery is fitted. In the former case, the battery should be replaced and recharged. In the latter case, the battery check should be disabled (see section 3.4.26). It is important that the battery fault be acted upon as soon as noticed, as excessive discharge may cause damage to the battery. The battery fault condition comes on before the battery reaches this portion of the discharge curve.

**Watchdog reset** : This indicates that there has been a power supply fault. If there are frequent power outages it may be advisable to power the unit from a UPS.

**Detector fault** : This indicates that there is a problem with the detector head. This may be due to a number of causes. Refer to the chart readout if this can be downloaded to a PC and note the detector signal level at the time of the fault. When as much information as possible has been determined about the conditions at the time of the error, please contact the Kidde Products Ltd help line (see page 3).

## 13. Do's and Don'ts

### **DO**

- ✓ Ensure that the ClassiFire alarm factor is appropriately set.
- ✓ Ensure that power and signal cables are correctly connected before powering up by use of cable identifiers or electrical continuity checks. Incorrect connection could damage the detector.
- ✓ Ensure that cable of an appropriate approved type is used for interconnection.
- ✓ Place sampling points so that the detector will be able to detect smoke at the earliest opportunity.
- ✓ Ensure that the detector exhaust is in an area with the same atmospheric pressure as the sampling pipes, either by placing the detector physically in the protected area or by leading a pipe from the detector exhaust to the protected area.
- ✓ Ensure that the environment of the protected area is within the environmental operating parameters of the detector (temperature -10 to +60°C, (humidity 0-90%, non-condensing).
- ✓ Close unused pipe inlet ports on the detector to ensure optimal operation.

### **DON'T**

- ✗ Forget to set the appropriate ClassiFire alarm factor for the area to be detected.
- ✗ Forget to set the Detector Address Switches correctly when used in a network.
- ✗ Site detectors in damp or exposed areas.
- ✗ Remove or connect boards when the detector is powered up.
- ✗ Connect internal 0 volt terminals to local earth.
- ✗ Attempt to re-use dust separator cartridges once removed.
- ✗ Attempt to adjust or alter detector settings other than via the user-programmable functions. In particular, the setting up of the laser is a precision task, and once set up the potentiometers should be left alone. If it is suspected that the laser focus has shifted (e.g. after dropping the detector), it should be returned to the manufacturer for recalibration.
- ✗ Place the detector near high power RF sources.
- ✗ Place the detector so close to other equipment that there is insufficient room to access and change the dust separator. See section 10. 'Maintenance'.
- ✗ Use sampling pipe of less than 27mm outside diameter without a suitable 27mm pipe adapter.
- ✗ Use excessive force when fitting sampling pipes as this may damage the detector.

## 14. Stratos-HSSD-2 specification

**NB**  This equipment is only to be used in accordance with this specification. Failure to operate the equipment as specified may cause damage to the unit.

SELV rating (EN 60950)	Class III
Supply Voltage	21.6V - 26.4V DC PSU Type: conforming to EN 54-4 Electrical safety complies with IEC 61010-1
Size (mm)	427W x 372H x 95D
Weight	5.2kg (Detector) 5.3kg (Command Module Detector) 6.2kg (Stand-alone Command Module) 10.1kg (Stand-alone Command Module + batteries)
Operating temperature range	0 to +38°C (UL 268 compliance) -10 to + 60°C (EN 54-20 compliance)
Operating humidity range	0 - 90% Non Condensing IEC 61010-1 Pollution degree 1 IEC 61010-1 Installation Cat. II
Sensitivity range (%Obs/m)	Min = 25% Max = 0.03% FSD
Maximum sensitivity resolution	0.0015 %Obs/m
Detection principle	Laser light scattering mass detection
Particle sensitivity range	0.0003µm to 10µm
Current consumption	Detector: 300mA (fan speed 1), 470mA (fan speed 8), 750mA (fan speed 16) Command Module Detector: 750mA (fan speed 1), 920mA (fan speed 8), 1.5A (fan speed 16). Stand-alone Command Module: 450mA 500mA @ 30V
Relay contact rating	500mA @ 30V
Maximum sampling pipe length	200 metres total
Sampling pipe inlets	4
Sampling pipe internal diameter	15-25mm
Alarm levels	4 (Fire 2, Fire 1, PreAlarm and Aux)
Bargraph sensitivity range	0.0015 - 25% obs/m
Bargraph segments	26
Chamber service intervals	Greater than 8 years (depending on environment)
Dust separator replacement intervals	Greater than 5 years (depending on environment)
Laser lifetime (MTTF)	Greater than 1000 years
Programming	Front panel or PC via RS232/RS485
Data bus cable	RS485 data cable
Data bus length	1.2 km IN, 1.2km OUT
IP rating	IP50
Supported languages on internal programmer	Czech                      Dutch English                    Estonian Finnish                    French German                    Hungarian Italian                    Norwegian Spanish                    Swedish



A UTC Fire & Security Company

Kidde Products Limited • Unit 2 Blair Way Dawdon • City: Seaham,  
County Durham, SR7 7PP United Kingdom  
Tel: +44(0)191-513 6100 Fax: +44(0)191-513 6102